



OWNER'S MANUAL

XMAX

MOTORCYCLE

 Read this manual carefully before operating this vehicle.

YP125RA

2DM-F8199-E3 ●

 **Read this manual carefully before operating this vehicle. This manual should stay with this vehicle if it is sold.**

Declaration of Conformity:

Hereby, YAMAHA MOTOR ELECTRONICS Co., Ltd declares that the radio equipment type, IMMOBILIZER, 37P-00 is in compliance with Directive 2014/53/EU. The full text of the EU declaration of conformity is available at the following internet address:

https://global.yamaha-motor.com/eu_doc/

Frequency band: 134.2 kHz

The maximum radio frequency power: 49.0 [dB μ V/m]

Manufacturer:

YAMAHA MOTOR ELECTRONICS Co., Ltd

1450-6 Mori, Mori-machi, Shuchi-Gun, Shizuoka, 437-0292 Japan

Importer:

YAMAHA MOTOR EUROPE N.V.

Koolhovenlaan 101, 1119 NC Schiphol-Rijk, 1117 ZN, Schiphol, the Netherlands

Welcome to the Yamaha world of motorcycling!

As the owner of the YP125RA, you are benefiting from Yamaha's vast experience and newest technology regarding the design and manufacture of high-quality products, which have earned Yamaha a reputation for dependability.

Please take the time to read this manual thoroughly, so as to enjoy all advantages of your YP125RA. The Owner's Manual does not only instruct you in how to operate, inspect and maintain your scooter, but also in how to safeguard yourself and others from trouble and injury.

In addition, the many tips given in this manual will help keep your scooter in the best possible condition. If you have any further questions, do not hesitate to contact your Yamaha dealer.

The Yamaha team wishes you many safe and pleasant rides. So, remember to put safety first!

Yamaha continually seeks advancements in product design and quality. Therefore, while this manual contains the most current product information available at the time of printing, there may be minor discrepancies between your scooter and this manual. If there is any question concerning this manual, please consult a Yamaha dealer.

 WARNING

Please read this manual carefully and completely before operating this scooter.







TIP

- This mark identifies the recommended fuel for this vehicle as specified by European regulation (EN228).
 - Check that gasoline nozzle has the same identifier when fueling.
-

Important manual information

EAU63350

Particularly important information is distinguished in this manual by the following notations:

	This is the safety alert symbol. It is used to alert you to potential personal injury hazards. Obey all safety messages that follow this symbol to avoid possible injury or death.
	A WARNING indicates a hazardous situation which, if not avoided, could result in death or serious injury.
	A NOTICE indicates special precautions that must be taken to avoid damage to the vehicle or other property.
	A TIP provides key information to make procedures easier or clearer.

*Product and specifications are subject to change without notice.

EAM1013

**YP125RA
OWNER'S MANUAL
©2016 by MBK INDUSTRIE
1st edition, April 2016
All rights reserved
Any reprinting or unauthorized use
without the written permission of
MBK INDUSTRIE
is expressly prohibited.
Printed in France.**

Table of contents

Safety information	1-1	Periodic maintenance chart for the emission control system.....	6-3
Further safe-riding points.....	1-5	General maintenance and lubrication chart.....	6-4
Description	2-1	Removing and installing panels	6-7
Left view	2-1	Checking the spark plug.....	6-9
Right view.....	2-2	Engine oil	6-10
Controls and instruments.....	2-3	Final transmission oil	6-13
Instrument and control functions	3-1	Coolant	6-14
Immobilizer system	3-1	Air filter and V-belt case air filter elements and check hoses.....	6-15
Main switch/steering lock	3-2	Checking the throttle grip free play	6-17
Indicator lights and warning lights	3-4	Valve clearance.....	6-17
Multi-function meter unit.....	3-6	Tires	6-18
Handlebar switches.....	3-13	Cast wheels	6-20
Front brake lever	3-14	Checking the front and rear brake lever free play	6-20
Rear brake lever	3-15	Checking the front and rear brake pads.....	6-21
ABS	3-15	Checking the brake fluid level.....	6-22
Fuel tank cap.....	3-16	Changing the brake fluid.....	6-23
Fuel.....	3-17	Checking and lubricating the cables	6-24
Catalytic converters	3-18	Checking and lubricating the throttle grip and cable	6-24
Seat	3-19	Lubricating the front and rear brake levers	6-25
Storage compartments	3-20	Checking and lubricating the centerstand and sidestand.....	6-25
Adjusting the shock absorber assemblies.....	3-21	Checking the front fork	6-26
Sidestand	3-22	Checking the steering.....	6-26
Ignition circuit cut-off system.....	3-23	Checking the wheel bearings	6-27
For your safety – pre-operation checks	4-1	Battery	6-27
Operation and important riding points	5-1	Replacing the fuses	6-29
Starting the engine	5-2	Replacing a headlight bulb	6-30
Starting off.....	5-3	Auxiliary light bulbs.....	6-31
Acceleration and deceleration.....	5-3	Tail/brake light	6-31
Braking	5-4	Front turn signal light	6-32
Tips for reducing fuel consumption	5-5	Replacing a rear turn signal light bulb.....	6-32
Engine break-in	5-5	Replacing the license plate light bulb.....	6-33
Parking	5-6	Troubleshooting	6-34
Periodic maintenance and adjustment	6-1	Troubleshooting charts.....	6-35
Owner's tool kit	6-2		

Table of contents

Scooter care and storage	7-1
Matte color caution	7-1
Care	7-1
Storage	7-4
Specifications	8-1
Consumer information	9-1
Identification numbers	9-1
Diagnostic connectors	9-2
Vehicle data recording	9-2
Index	10-1

EAU1026B

Be a Responsible Owner

As the vehicle's owner, you are responsible for the safe and proper operation of your scooter.

Scooters are single-track vehicles.

Their safe use and operation are dependent upon the use of proper riding techniques as well as the expertise of the operator. Every operator should know the following requirements before riding this scooter.

He or she should:

- Obtain thorough instructions from a competent source on all aspects of scooter operation.
- Observe the warnings and maintenance requirements in this Owner's Manual.
- Obtain qualified training in safe and proper riding techniques.
- Obtain professional technical service as indicated in this Owner's Manual and/or when made necessary by mechanical conditions.
- Never operate a scooter without proper training or instruction. Take a training course. Beginners should receive training from a certified instructor. Contact an authorized scooter dealer to find out about the training courses nearest you.

Safe Riding

Perform the pre-operation checks each time you use the vehicle to make sure it is in safe operating condition. Failure to inspect or maintain the vehicle properly increases the possibility of

an accident or equipment damage. See page 4-1 for a list of pre-operation checks.

- This scooter is designed to carry the operator and a passenger.
- The failure of motorists to detect and recognize scooters in traffic is the predominating cause of automobile/scooter accidents. Many accidents have been caused by an automobile driver who did not see the scooter. Making yourself conspicuous appears to be very effective in reducing the chance of this type of accident.

Therefore:

- Wear a brightly colored jacket.
- Use extra caution when you are approaching and passing through intersections, since intersections are the most likely places for scooter accidents to occur.
- Ride where other motorists can see you. Avoid riding in another motorist's blind spot.
- Never maintain a scooter without proper knowledge. Contact an authorized scooter dealer to inform you on basic scooter maintenance. Certain maintenance can only be carried out by certified staff.
- Many accidents involve inexperienced operators. In fact, many operators who have been involved in accidents do not even have a current driver's license.
- Make sure that you are qualified and that you only lend your scooter to other qualified operators.

Safety information

1

- Know your skills and limits. Staying within your limits may help you to avoid an accident.
- We recommend that you practice riding your scooter where there is no traffic until you have become thoroughly familiar with the scooter and all of its controls.
- Many accidents have been caused by error of the scooter operator. A typical error made by the operator is veering wide on a turn due to excessive speed or undercornering (insufficient lean angle for the speed).
 - Always obey the speed limit and never travel faster than warranted by road and traffic conditions.
 - Always signal before turning or changing lanes. Make sure that other motorists can see you.
- The posture of the operator and passenger is important for proper control.
 - The operator should keep both hands on the handlebar and both feet on the operator footrests during operation to maintain control of the scooter.
 - The passenger should always hold onto the operator, the seat strap or grab bar, if equipped, with both hands and keep both feet on the passenger footrests. Never carry a passenger unless he or she can firmly place both feet on the passenger footrests.
- Never ride under the influence of alcohol or other drugs.
- This scooter is designed for on-road use only. It is not suitable for off-road use.

Protective Apparel

The majority of fatalities from scooter accidents are the result of head injuries. The use of a safety helmet is the single most critical factor in the prevention or reduction of head injuries.

- Always wear an approved helmet.
- Wear a face shield or goggles. Wind in your unprotected eyes could contribute to an impairment of vision that could delay seeing a hazard.
- The use of a jacket, substantial shoes, trousers, gloves, etc., is effective in preventing or reducing abrasions or lacerations.
- Never wear loose-fitting clothes, otherwise they could catch on the control levers or wheels and cause injury or an accident.
- Always wear protective clothing that covers your legs, ankles, and feet. The engine or exhaust system become very hot during or after operation and can cause burns.
- A passenger should also observe the above precautions.

Avoid Carbon Monoxide Poisoning

All engine exhaust contains carbon monoxide, a deadly gas. Breathing carbon monoxide can cause headaches, dizziness, drowsiness, nausea, confusion, and eventually death.

Carbon Monoxide is a colorless, odorless, tasteless gas which may be present even if you do not see or smell any

engine exhaust. Deadly levels of carbon monoxide can collect rapidly and you can quickly be overcome and unable to save yourself. Also, deadly levels of carbon monoxide can linger for hours or days in enclosed or poorly ventilated areas. If you experience any symptoms of carbon monoxide poisoning, leave the area immediately, get fresh air, and **SEEK MEDICAL TREATMENT**.

- Do not run engine indoors. Even if you try to ventilate engine exhaust with fans or open windows and doors, carbon monoxide can rapidly reach dangerous levels.
- Do not run engine in poorly ventilated or partially enclosed areas such as barns, garages, or carports.
- Do not run engine outdoors where engine exhaust can be drawn into a building through openings such as windows and doors.

Loading

Adding accessories or cargo to your scooter can adversely affect stability and handling if the weight distribution of the scooter is changed. To avoid the possibility of an accident, use extreme caution when adding cargo or accessories to your scooter. Use extra care when riding a scooter that has added cargo or accessories. Here, along with the information about accessories below, are some general guidelines to follow if loading cargo to your scooter:

The total weight of the operator, passenger, accessories and cargo must not exceed the maximum load limit.

Operation of an overloaded vehicle could cause an accident.

Maximum load: 181 kg (399 lb)

When loading within this weight limit, keep the following in mind:

- Cargo and accessory weight should be kept as low and close to the scooter as possible. Securely pack your heaviest items as close to the center of the vehicle as possible and make sure to distribute the weight as evenly as possible on both sides of the scooter to minimize imbalance or instability.
- Shifting weights can create a sudden imbalance. Make sure that accessories and cargo are securely attached to the scooter before riding. Check accessory mounts and cargo restraints frequently.
- Properly adjust the suspension for your load (suspension-adjustable models only), and check the condition and pressure of your tires.
- Never attach any large or heavy items to the handlebar, front fork, or front fender. Such items can create unstable handling or a slow steering response.
- **This vehicle is not designed to pull a trailer or to be attached to a sidecar.**

Safety information

1

Genuine Yamaha Accessories

Choosing accessories for your vehicle is an important decision. Genuine Yamaha accessories, which are available only from a Yamaha dealer, have been designed, tested, and approved by Yamaha for use on your vehicle.

Many companies with no connection to Yamaha manufacture parts and accessories or offer other modifications for Yamaha vehicles. Yamaha is not in a position to test the products that these aftermarket companies produce. Therefore, Yamaha can neither endorse nor recommend the use of accessories not sold by Yamaha or modifications not specifically recommended by Yamaha, even if sold and installed by a Yamaha dealer.

Aftermarket Parts, Accessories, and Modifications

While you may find aftermarket products similar in design and quality to genuine Yamaha accessories, recognize that some aftermarket accessories or modifications are not suitable because of potential safety hazards to you or others. Installing aftermarket products or having other modifications performed to your vehicle that change any of the vehicle's design or operation characteristics can put you and others at greater risk of serious injury or death. You are responsible for injuries related to changes in the vehicle.

Keep the following guidelines in mind, as well as those provided under "Loading" when mounting accessories.

- Never install accessories or carry cargo that would impair the performance of your scooter. Careful-

ly inspect the accessory before using it to make sure that it does not in any way reduce ground clearance or cornering clearance, limit suspension travel, steering travel or control operation, or obscure lights or reflectors.

- Accessories fitted to the handlebar or the front fork area can create instability due to improper weight distribution or aerodynamic changes. If accessories are added to the handlebar or front fork area, they must be as lightweight as possible and should be kept to a minimum.
- Bulky or large accessories may seriously affect the stability of the scooter due to aerodynamic effects. Wind may attempt to lift the scooter, or the scooter may become unstable in cross winds. These accessories may also cause instability when passing or being passed by large vehicles.
- Certain accessories can displace the operator from his or her normal riding position. This improper position limits the freedom of movement of the operator and may limit control ability, therefore, such accessories are not recommended.
- Use caution when adding electrical accessories. If electrical accessories exceed the capacity of the scooter's electrical system, an electric failure could result, which could cause a dangerous loss of lights or engine power.

Aftermarket Tires and Rims

The tires and rims that came with your scooter were designed to match the performance capabilities and to provide the best combination of handling, braking, and comfort. Other tires, rims, sizes, and combinations may not be appropriate. Refer to page 6-18 for tire specifications and more information on replacing your tires.

Transporting the Scooter

Be sure to observe following instructions before transporting the scooter in another vehicle.

- Remove all loose items from the scooter.
- Point the front wheel straight ahead on the trailer or in the truck bed, and choke it in a rail to prevent movement.
- Secure the scooter with tie-downs or suitable straps that are attached to solid parts of the scooter, such as the frame or upper front fork triple clamp (and not, for example, to rubber-mounted handlebars or turn signals, or parts that could break). Choose the location for the straps carefully so the straps will not rub against painted surfaces during transport.
- The suspension should be compressed somewhat by the tie-downs, if possible, so that the scooter will not bounce excessively during transport.

Further safe-riding points

- Be sure to signal clearly when making turns.
- Braking can be extremely difficult on a wet road. Avoid hard braking, because the scooter could slide. Apply the brakes slowly when stopping on a wet surface.
- Slow down as you approach a corner or turn. Once you have completed a turn, accelerate slowly.
- Be careful when passing parked cars. A driver might not see you and open a door in your path.
- Railroad crossings, streetcar rails, iron plates on road construction sites, and manhole covers become extremely slippery when wet. Slow down and cross them with caution. Keep the scooter upright, otherwise it could slide out from under you.
- The brake pads or linings could get wet when you wash the scooter. After washing the scooter, check the brakes before riding.
- Always wear a helmet, gloves, trousers (tapered around the cuff and ankle so they do not flap), and a brightly colored jacket.
- Do not carry too much luggage on the scooter. An overloaded scooter is unstable. Use a strong cord to secure any luggage to the carrier (if equipped). A loose load will affect the stability of the scooter and could divert your attention from the road. (See page 1-3.)

Description

EAU63371

Left view

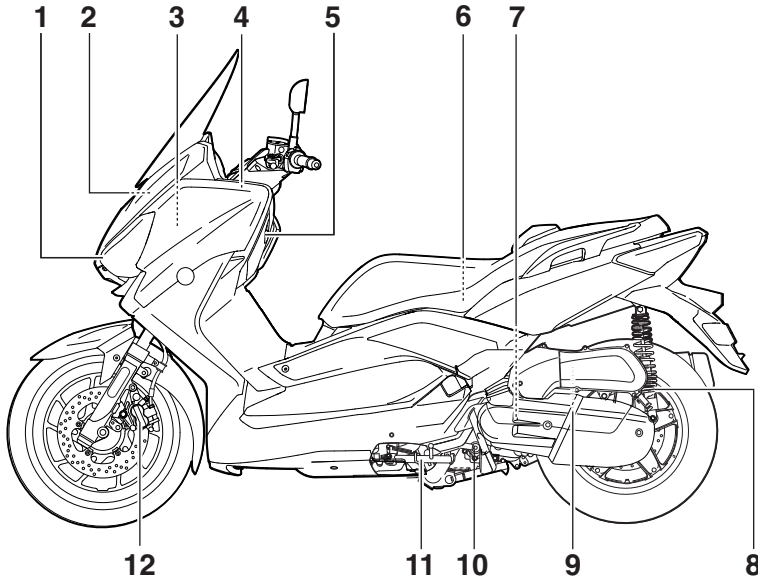

1. Headlight (page 6-30)
2. Battery (page 6-27)
3. Main fuse (page 6-29)
4. Coolant reservoir cap (page 6-14)
5. Coolant level check window (page 6-14)
6. Rear storage compartment (page 3-20)
7. V-belt case air filter element (page 6-15)
8. Shock absorber assembly spring preload adjusting ring (page 3-21)
9. Air filter element (left) (page 6-15)
10. Engine oil filter element (page 6-10)
11. Sidestand (page 3-22)
12. Front brake pads (page 6-21)

Right view

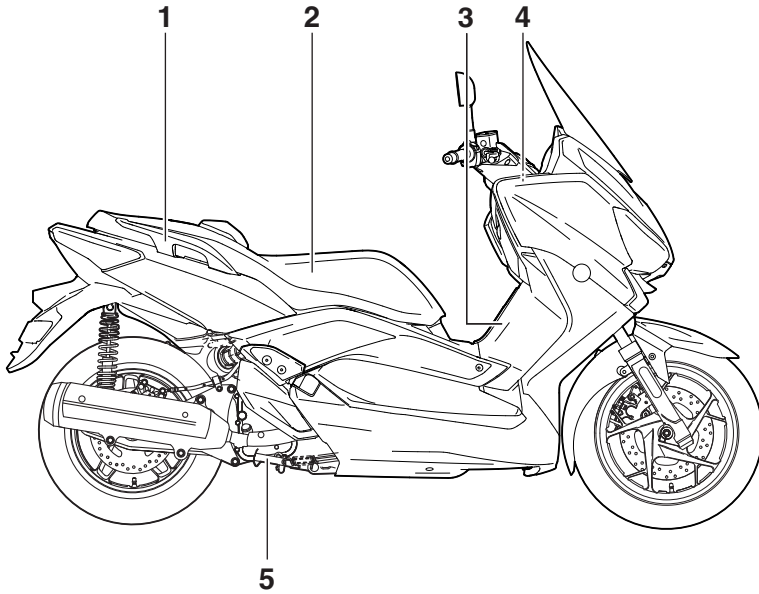

1. Grab bar (page 5-3)
2. Seat (page 3-19)
3. Fuel tank cap (page 3-16)
4. Fuses (page 6-29)
5. Centerstand (page 6-25)

Controls and instruments

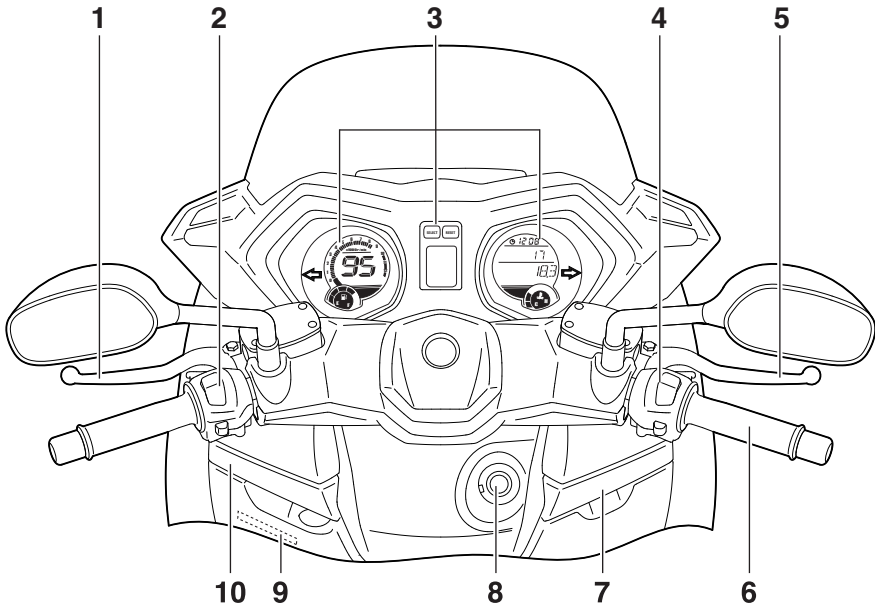

1. Rear brake lever (page 3-15)
2. Left handlebar switches (page 3-13)
3. Multi-function meter unit (page 3-6)
4. Right handlebar switches (page 3-13)
5. Front brake lever (page 3-14)
6. Throttle grip (page 6-17)
7. Front storage compartment B (page 3-20)
8. Main switch/steering lock (page 3-2)
9. Coolant level check window (page 6-14)
10. Front storage compartment A (page 3-20)

Immobilizer system

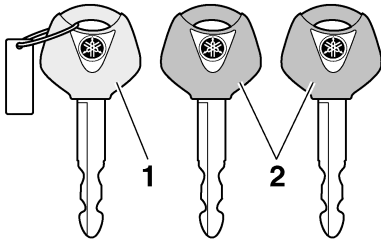

1. Code re-registering key (red bow)
2. Standard keys (black bow)

This vehicle is equipped with an immobilizer system to help prevent theft by re-registering codes in the standard keys. This system consists of the following:

- a code re-registering key (with a red bow)
- two standard keys (with a black bow) that can be re-registered with new codes
- a transponder (which is installed in the code re-registering key)
- an immobilizer unit
- an ECU
- an immobilizer system indicator light (See page 3-5.)

The key with the red bow is used to register codes in each standard key. Since re-registering is a difficult process, take the vehicle along with all three keys to a Yamaha dealer to have them re-registered. Do not use the key with the red bow for driving. It should only be used for re-registering the standard keys. Always use a standard key for driving.

NOTICE

- **DO NOT LOSE THE CODE RE-REGISTERING KEY! CONTACT YOUR DEALER IMMEDIATELY IF IT IS LOST!** If the code re-registering key is lost, registering new codes in the standard keys is impossible. The standard keys can still be used to start the vehicle, however if code re-registering is required (i.e., if a new standard key is made or all keys are lost) the entire immobilizer system must be replaced. Therefore, it is highly recommended to use either standard key and keep the code re-registering key in a safe place.
- Do not submerge any key in water.
- Do not expose any key to excessively high temperatures.
- Do not place any key close to magnets (this includes, but not limited to, products such as speakers, etc.).
- Do not place items that transmit electrical signals close to any key.
- Do not place heavy items on any key.
- Do not grind any key or alter its shape.
- Do not disassemble the plastic part of any key.
- Do not put two keys of any immobilizer system on the same key ring.

Instrument and control functions

- Keep the standard keys as well as keys of other immobilizer systems away from this vehicle's code re-registering key.
- Keep other immobilizer system keys away from the main switch as they may cause signal interference.

3

Main switch/steering lock

EAU10474

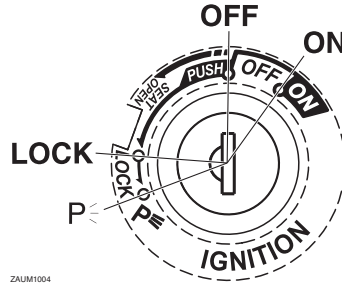

ZALUM1004

The main switch/steering lock controls the ignition and lighting systems, and is used to lock the steering. The various positions are described below.

TIP

Be sure to use the standard key (black bow) for regular use of the vehicle. To minimize the risk of losing the code re-registering key (red bow), keep it in a safe place and only use it for code re-registering.

ON

EAU34122

All electrical circuits are supplied with power; the meter lighting, taillight, license plate light and auxiliary lights come on, and the engine can be started. The key cannot be removed.

TIP

The headlights come on automatically when the engine is started and stay on until the key is turned to "OFF" or the sidestand is moved down.

OFF

EAU10662

All electrical systems are off. The key can be removed.

! WARNING

Never turn the key to “OFF” or “LOCK” while the vehicle is moving. Otherwise the electrical systems will be switched off, which may result in loss of control or an accident.

NOTICE

Using the hazard or turn signal lights for an extended length of time may cause the battery to discharge.

LOCK

The steering is locked and all electrical systems are off. The key can be removed.

To lock the steering

1. Turn the handlebars all the way to the left.
2. With the key in the “OFF” position, push the key in and turn it to “LOCK”.
3. Remove the key.

TIP

If the steering will not lock, try turning the handlebars back to the right slightly.

To unlock the steering

From the “LOCK” position, push the key in and turn it to “OFF”.

P \leq (Parking)

The hazard lights and turn signal lights can be turned on, but all other electrical systems are off. The key can be removed.

The steering must be locked before the key can be turned to “P \leq ”.

Instrument and control functions

Indicator lights and warning lights

EAU49399

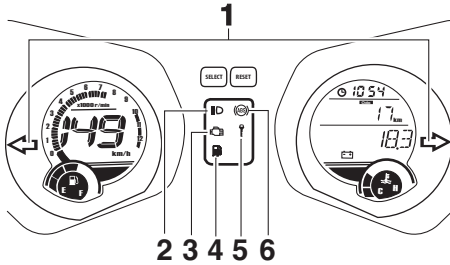

ZAUM1098

1. Turn signal indicator lights “↵” and “⇨”
2. High beam indicator light “≡○”
3. Engine trouble warning light “⚠️”
4. Fuel level warning light “⛽”
5. Immobilizer system indicator light “🔑”
6. Anti-lock Brake System (ABS) warning light “⊖”

Turn signal indicator lights “↵” and “⇨”

EAU11032

Each indicator light will flash when its corresponding turn signal lights are flashing.

High beam indicator light “≡○”

EAU11081

This indicator light comes on when the high beam of the headlight is switched on.

Fuel level warning light “⛽”

EAU11354

This warning light comes on when the fuel level drops below approximately 2.5 L (0.66 US gal, 0.55 Imp.gal). When this occurs, refuel as soon as possible. The electrical circuit of the warning light can be checked by turning the key to “ON”. The warning light should come on for a few seconds, and then go off.

If the warning light does not come on initially when the key is turned to “ON”, or if the warning light remains on, have a Yamaha dealer check the electrical circuit.

Engine trouble warning light “⚠️”

EAU11486

This warning light comes on if a problem is detected in the electrical circuit monitoring the engine. If this occurs, have a Yamaha dealer check the vehicle.

The electrical circuit of the warning light can be checked by turning the key to “ON”. The warning light should come on for a few seconds, and then go off.

If the warning light does not come on initially when the key is turned to “ON”, or if the warning light remains on, have a Yamaha dealer check the electrical circuit.

ABS warning light “⊖”

EAU11810

In normal operation, the ABS warning light comes on when the key is turned to “ON”, and goes off after traveling at a speed of 10 km/h (6 mi/h) or higher. If the ABS warning light:

- does not come on when the key is turned to “ON”
- comes on or flashes while riding
- does not go off after traveling at a speed of 10 km/h (6 mi/h) or higher

The ABS may not work correctly. If any of the above occurs, have a Yamaha dealer check the system as soon as possible. (See page 3-15 for an explanation of the ABS.)

Instrument and control functions

EWA16041

WARNING

If the ABS warning light does not go off after traveling at a speed of 10 km/h (6 mi/h) or higher, or if the warning light comes on or flashes while riding, the brake system reverts to conventional braking. If either of the above occurs, or if the warning light does not come on at all, use extra caution to avoid possible wheel lock during emergency braking. Have a Yamaha dealer check the brake system and electrical circuits as soon as possible.

TIP

The ABS warning light may come on while accelerating the engine with the vehicle on its centerstand, but this does not indicate a malfunction.

EAUM3621

Immobilizer system indicator light “ ”

When the key is turned to “OFF” and 30 seconds have passed, the indicator light will flash steadily to indicate the immobilizer system is enabled. After 24 hours have passed, the indicator light will stop flashing, however the immobilizer system is still enabled.

The electrical circuit of the indicator light can be checked by turning the key to “ON”. The indicator light should come on for a few seconds, and then go off.

If the indicator light does not come on initially when the key is turned to “ON”, if the indicator light remains on, or if the indicator light flashes in a pattern (if a problem is detected in the immobilizer

system, the immobilizer system indicator light will flash in a pattern), have a Yamaha dealer check the vehicle.

TIP

If the immobilizer system indicator light flashes in the pattern, slowly 5 times then quickly 2 times, this could be caused by transponder interference. If this occurs, try the following.

1. Make sure there are no other immobilizer keys close to the main switch. Other immobilizer system keys may cause signal interference and prevent the engine from starting.
2. Use the code re-registering key to start the engine.
3. If the engine starts, turn it off, and try starting the engine with the standard keys.
4. If one or both of the standard keys do not start the engine, take the vehicle and all 3 keys to a Yamaha dealer to have the standard keys re-registered.

Instrument and control functions

Multi-function meter unit

EAUM3831

EWA12423

⚠ WARNING

Be sure to stop the vehicle before making any setting changes to the multi-function meter unit. Changing settings while riding can distract the operator and increase the risk of an accident.

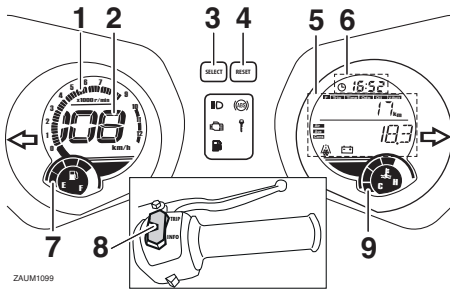

ZAUM1099

1. Tachometer
2. Speedometer
3. “SELECT” button
4. “RESET” button
5. Multi-function display
6. Clock
7. Fuel meter
8. “TRIP/INFO” switch
9. Coolant temperature display

The multi-function meter unit is equipped with the following:

- a speedometer
- a tachometer
- a fuel meter
- a clock
- an odometer and tripmeter display
- a multi-function display
- a coolant temperature meter

TIP

- Be sure to turn the key to “ON” before using the “SELECT”, “RESET”, “TRIP” and “INFO” buttons.

- When the key is turned to “ON”, all display segments of the multi-function meter unit will momentarily appear in order to test the electrical circuit. The speedometer and odometer will then perform a display check and a welcome message will scroll across the multi-function display.
- Traveling speed, distance traveled and fuel consumption measurements are displayed in kilometer-based units.
- For the UK: traveling speed, distance traveled and fuel consumption measurements can be displayed in mile-based units. To switch between kilometers or miles: hold the “SELECT” switch pushed, turn the main switch to “ON”, and keep the “SELECT” switch pushed for an additional 8 seconds.

Speedometer

The speedometer shows the vehicle's traveling speed.

Tachometer

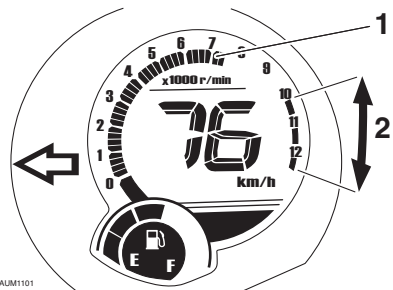

ZAUM1101

1. Tachometer
2. High-rpm zone

Instrument and control functions

The tachometer allows you to monitor the engine speed and keep it within the ideal power range.

ECAM11150

NOTICE

Do not operate the engine in the tachometer high-rpm zone.
High-rpm zone: 10000 r/min and above

Fuel meter

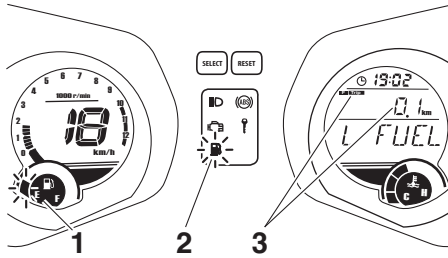

ZAUM1102

1. Fuel meter
2. Fuel level warning indicator “”
3. Fuel reserve tripmeter

With the key in the “ON” position, the fuel meter indicates the amount of fuel in the fuel tank. The display segments of the fuel meter start from “F” (full) and disappear towards “E” (empty) as the fuel level decreases. When the fuel level is low, the fuel pictogram “” and the last segment will flash. Refuel as soon as possible.

TIP

The fuel meter is equipped with a self-diagnosis system. If a problem is detected in the fuel tank electrical circuit, all segments of the fuel meter will flash repeatedly. If this occurs, have a Yamaha dealer check the vehicle.

Clock

To set the clock:

1. Push the “SELECT” button for 3 seconds, and the hour digits will start flashing.
2. Use the “SELECT” button to set the hours.
3. Push the “SELECT” button for 3 seconds, and the minute digits will start flashing.
4. Use the “SELECT” button to set the minutes.
5. Push the “SELECT” button for 3 seconds to complete setting the clock.

Odometer and tripmeter display

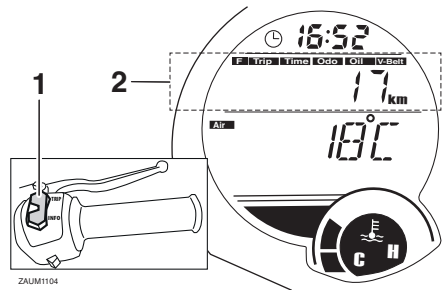

ZAUM1104

1. “TRIP/INFO” switch
2. Function display

The odometer and tripmeter display is equipped with the following:

- an odometer (which shows the total distance the vehicle has traveled)
- a tripmeter (which shows the distance traveled since last set to zero)
- a time tripmeter (which shows the elapsed riding time since last set to zero)

Instrument and control functions

3

- a fuel reserve tripmeter (which shows the distance traveled since the fuel level warning light came on)
- an oil change tripmeter (which shows the distance traveled since the last engine oil change)
- a V-belt replacement tripmeter (which shows the distance traveled since the last V-belt replacement)

Push the “TRIP” button to switch the display in the following order:

Odo (odometer) → Trip (tripmeter) → Trip Time (time tripmeter) → Oil (oil change tripmeter) → V-Belt (v-belt replacement tripmeter) → Odo (odometer)

When approximately 2.5 L (0.66 US gal, 0.55 Imp.gal) of fuel remains in the fuel tank, the display will automatically change to the fuel reserve tripmeter mode “F Trip” and start counting the distance traveled from that point. In this case, push the “TRIP” button to switch the display in the following order:

Odo → Trip → Trip Time → F Trip (fuel reserve tripmeter) → Oil Trip → V-Belt Trip → Odo

To reset a standard tripmeter (not oil change or V-belt change tripmeter), select it by pushing the “TRIP” button until “Trip”, “Trip Time”, “F Trip” is displayed. While “Trip, Trip Time, F Trip” is displayed, push the “TRIP” button for 3 seconds. If you do not reset the fuel reserve tripmeter manually, it will reset automatically and disappear after refueling and traveling 5 km (3 mi).

TIP

- The display cannot be changed back to “F Trip” after it has been reset.
- The tripmeter will reset and continue counting after 9999.9 is reached.
- The odometer will lock at 999999 and cannot be reset.

Oil change indicator “Oil”

This indicator flashes at the initial 1000 km (600 mi), then at 5000 km (3000 mi) and every 6000 km (3500 mi) thereafter to indicate that the engine oil should be changed. After changing the engine oil, reset the oil change indicator.

To reset the oil change indicator

1. Turn the key to “ON”.
2. Push the “TRIP” button until “Oil” (oil change tripmeter) is displayed, and then push the “RESET” button for 3 seconds. The oil change tripmeter value will flash.

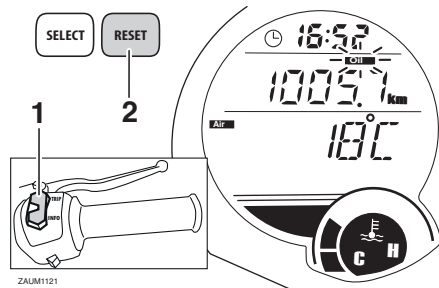

1. “TRIP/INFO” switch
2. “RESET” button
3. Hold the “RESET” button pushed for 15 to 20 seconds.

Instrument and control functions

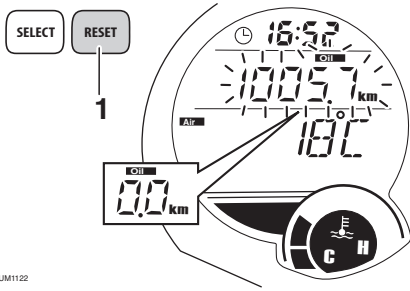

ZAJM1122

1. "RESET" button

4. Release the "RESET" button, and the oil trip value will reset to zero.

TIP

If the engine oil is changed before the oil change indicator comes on (i.e. before the periodic oil change interval has been reached), the indicator must be reset after the oil change for the next periodic oil change to be indicated at the correct time. To reset the oil change indicator before the periodic oil change interval has been reached, follow the above procedure.

The electrical circuit of the indicator can be checked according to the following procedure.

1. Turn the key to "ON".
2. Check that the oil change indicator comes on for a few seconds and then goes off.
3. If the oil change indicator does not come on, have a Yamaha dealer check the electrical circuit.

V-belt replacement indicator "V-Belt"

This indicator flashes every 18000 km (10500 mi) when the V-belt needs to be replaced. After changing the V-belt, reset the V-belt replacement indicator.

To reset the V-belt replacement indicator

1. Turn the key to "ON".
2. Push the "TRIP" button until "V-Belt" (V-belt replacement tripmeter) is displayed, and then push the "RESET" button for 3 seconds. The V-belt replacement tripmeter value will flash.

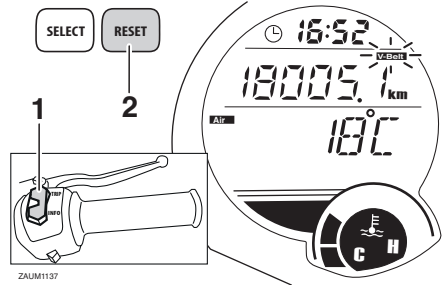

ZAJM1137

1. "TRIP/INFO" switch
2. "RESET" button

3. Hold the "RESET" button pushed for 15 to 20 seconds.

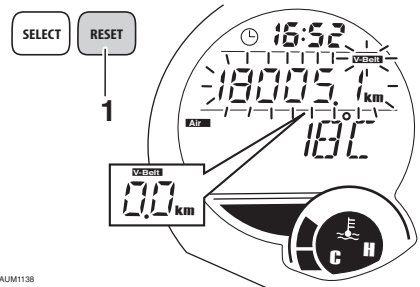

ZAJM1138

1. "RESET" button

4. Release the "RESET" button, and the V-belt trip value will reset to zero.

TIP

If the V-belt is replaced before the indicator comes on, be sure to reset the V-belt replacement indicator so that it will come on at the next correct interval.

Instrument and control functions

The electrical circuit of the indicator can be checked according to the following procedure.

1. Turn the key to "ON".
2. Check that the V-belt replacement indicator comes on for a few seconds and then goes off.
3. If the V-belt replacement indicator does not come on, have a Yamaha dealer check the electrical circuit.

3

Multi-function display

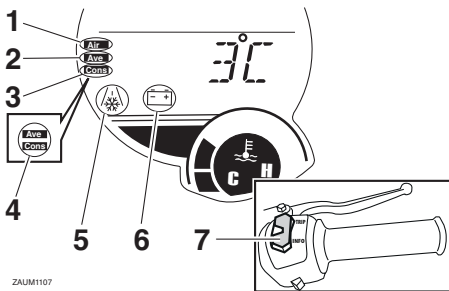

ZALUM107

1. Ambient temperature
2. Average speed
3. Instantaneous fuel consumption
4. Average fuel consumption
5. Icy road warning indicator "❄️"
6. Battery voltage
7. "TRIP/INFO" switch

The multi-function display is equipped with the following:

- an ambient temperature display
- a battery voltage level display
- a fuel consumption display (average and instantaneous)
- an average speed display
- a warning message function

Push the "INFO" button to switch the display between the ambient temperature "Air", the battery voltage $\left[\text{BAT} \right]$, the average fuel consumption "Ave/Cons___.km/L" or "Ave/Cons

___.L/100 km", the instantaneous fuel consumption "Cons___.km/L" or "Cons___.L/100 km", and the average speed "Ave" in the following order:

Air → $\left[\text{INFO} \right]$ → Ave/Cons___.km/L or L/100 km → Cons___.km/L or L/100 km → Ave → Air

For the UK:

If the display units have been set to miles, pushing the "INFO" button will switch the display in the following order:

Air → $\left[\text{INFO} \right]$ → Ave/Cons___.MPG → Cons___.MPG → Ave → Air

Ambient temperature display

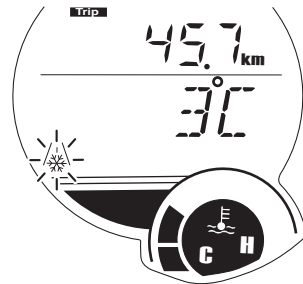

ZALUM108

This display shows the ambient temperature from $-10\text{ }^{\circ}\text{C}$ to $50\text{ }^{\circ}\text{C}$ in $1\text{ }^{\circ}\text{C}$ increments. The temperature displayed may vary from the actual ambient temperature.

TIP

The icy road warning indicator "❄️" will flash when the temperature is below $4\text{ }^{\circ}\text{C}$.

Instrument and control functions

Battery voltage display

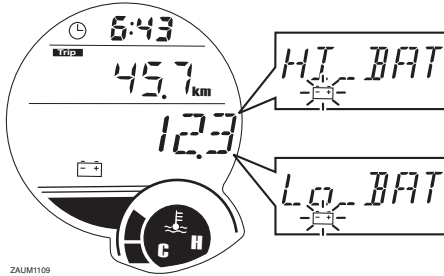

ZAJM1109

This display shows the battery voltage from 10.1 volts to 17.9 volts in 0.1 increments. The voltage displayed may vary slightly from the actual battery voltage.

TIP

If the battery warning indicator  flashes and the warning message "H BATT" (high battery voltage) or "L BATT" (low battery voltage) appears, have a Yamaha dealer check the battery.

Average fuel consumption display

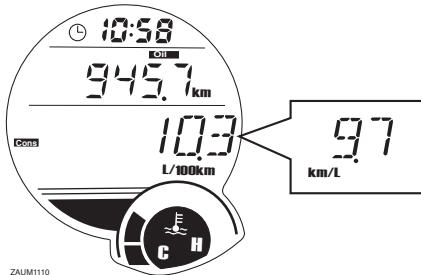

ZAJM1110

This display shows the average fuel consumption since it was last reset. The average fuel consumption display can be set to either "Ave/Cons_ _ _ km/L" or "Ave/Cons_ _ _ L/100 km".

For the UK: "Ave/Cons_ _ _ MPG" will be displayed when the multi-function meter unit has been set to miles.

- "Ave/Cons_ _ _ km/L" is the average distance that can be traveled on 1.0 L of fuel.
- "Ave/Cons_ _ _ L/100 km" is the average amount of fuel necessary to travel 100 km.
- "Ave/Cons_ _ _ MPG" is the average distance that can be traveled on 1.0 Imp.gal of fuel.

To reset the average fuel consumption display, push the "INFO" button for 3 seconds.

TIP

After resetting the average fuel consumption display, "_ _ _" will be shown until the vehicle has traveled 1 km (0.6 mi).

Instantaneous fuel consumption display

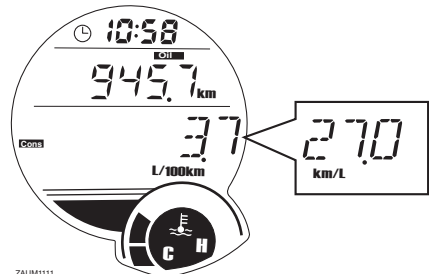

ZAJM1111

The instantaneous fuel consumption display can be set to either "km/L" or "L/100 km".

For the UK: "MPG" will be displayed when the multi-function meter unit has been set to miles.

- "km/L" is the distance that can be traveled on 1.0 L of fuel under current riding conditions.

Instrument and control functions

- “L/100 km” is the amount of fuel necessary to travel 100 km under current riding conditions.
- “MPG” is the distance that can be traveled on 1.0 Imp.gal of fuel under current riding conditions.

To switch between “km/L” and “L/100 km”, push the “INFO” button.

TIP

If traveling at speeds under 10 km/h (6.0 mi/h), “_ _ . _” is displayed.

Average speed display



ZALUM1112

This display shows the average speed since it was last reset. The average speed is calculated as the total distance traveled divided by the total time the key has been in the “ON” position since the last set to zero.

For the UK: “MPH” will be displayed when the multi-function meter unit has been set to miles.

To reset the average speed display, select it by pushing the “INFO” button, and then push the “INFO” button for 3 seconds.

Warning message function

When a vehicle irregularity, road or service condition has been detected, in addition to any corresponding warning lights or indicators, the following warning messages will display accordingly.

- L FUEL (low fuel)
- H TEMP (high coolant temperature)
- L BATT (low battery voltage)
- H BATT (high battery voltage)
- ICE (possible icy road conditions)
- OIL SERV (oil service required)
- V-BELT SERV (V-belt service required)

Coolant temperature meter

This meter indicates the temperature of the coolant, and thereby the engine. The coolant temperature varies with changes in the weather and engine load. If the “H” segment and the coolant temperature warning indicator start flashing, stop the vehicle and let the engine cool.

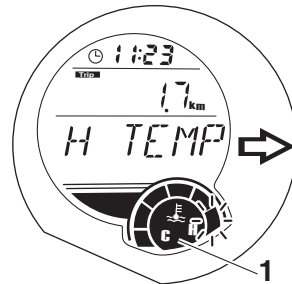

ZALUM1115

1. Coolant temperature meter

ECA10022

NOTICE

Do not continue to operate the engine if it is overheating.

Handlebar switches

EAU1234K

EAU12461

Left

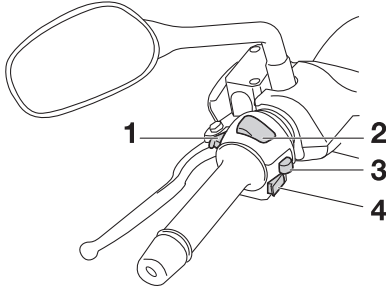

1. Pass switch “ $\equiv\bigcirc$ ”
2. Dimmer switch “ $\equiv\bigcirc/\equiv\bigcirc$ ”
3. Turn signal switch “ \leftarrow/\rightarrow ”
4. Horn switch “ 📢 ”

Right

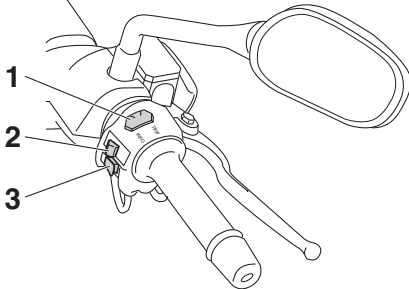

1. “TRIP/INFO” switch
2. Hazard switch “ \triangle ”
3. Start switch “ 📢 ”

Pass switch “ $\equiv\bigcirc$ ”

EAU12352

Press this switch to flash the headlight.

TIP

When the dimmer switch is set to “ $\equiv\bigcirc$ ”, the passing switch has no effect.

Dimmer switch “ $\equiv\bigcirc/\equiv\bigcirc$ ”

EAU12401

Set this switch to “ $\equiv\bigcirc$ ” for the high beam and to “ $\equiv\bigcirc$ ” for the low beam.

Turn signal switch “ \leftarrow/\rightarrow ”

To signal a right-hand turn, push this switch to “ \rightarrow ”. To signal a left-hand turn, push this switch to “ \leftarrow ”. When released, the switch returns to the center position. To cancel the turn signal lights, push the switch in after it has returned to the center position.

Horn switch “ 📢 ”

EAU12501

Press this switch to sound the horn.

Start switch “ 📢 ”

EAU12722

With the sidestand up, push this switch while applying the front or rear brake to crank the engine with the starter. See page 5-2 for starting instructions prior to starting the engine.

The engine trouble warning light will come on when the key is turned to “ON” and the start switch is pushed, but this does not indicate a malfunction.

EAU41701

Hazard switch “ \triangle ”

EAU12735

With the key in the “ON” or “P \leq ” position, use this switch to turn on the hazard lights (simultaneous flashing of all turn signal lights).

The hazard lights are used in case of an emergency or to warn other drivers when your vehicle is stopped where it might be a traffic hazard.

Instrument and control functions

ECA10062

NOTICE

Do not use the hazard lights for an extended length of time with the engine not running, otherwise the battery may discharge.

EAUM3720

Trip/info switch “TRIP/INFO”

This switch is used to make setting and display changes in the multi-function meter unit. See page 3-6 for more information.

Front brake lever

EAU12902

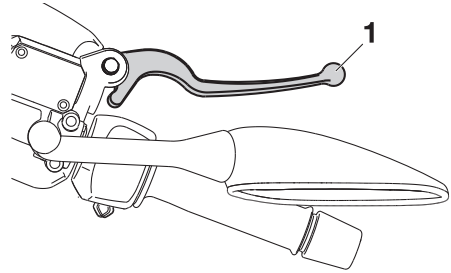

1. Front brake lever

The front brake lever is located on the right side of the handlebar. To apply the front brake, pull this lever toward the throttle grip.

Rear brake lever

EAU12952

EAU66680

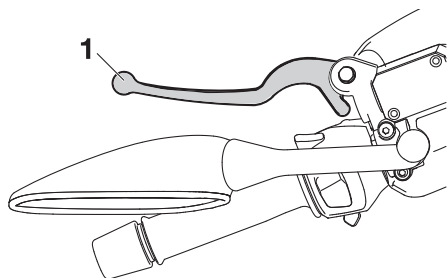

1. Rear brake lever

The rear brake lever is located on the left side of the handlebar. To apply the rear brake, pull this lever toward the handlebar grip.

ABS

The Yamaha ABS (Anti-lock Brake System) features a dual electronic control system, which acts on the front and rear brakes independently.

Operate the brakes with ABS as you would conventional brakes. If the ABS is activated, a pulsating sensation may be felt at the brake levers. In this situation, continue to apply the brakes and let the ABS work; do not “pump” the brakes as this will reduce braking effectiveness.

EWA16051

WARNING

Always keep a sufficient distance from the vehicle ahead to match the riding speed even with ABS.

- **The ABS performs best with long braking distances.**
- **On certain surfaces, such as rough or gravel roads, the braking distance may be longer with the ABS than without.**

The ABS is monitored by an ECU, which will revert the system to conventional braking if a malfunction occurs.

TIP

- The ABS performs a self-diagnosis test each time the vehicle first starts off after the key is turned to “ON” and the vehicle has traveled at a speed of 10 km/h (6 mi/h) or higher. During this test, a “clicking” noise can be heard from the front of the vehicle, and if either brake lever is even slightly applied, a vibration can be felt at the lever, but these do not indicate a malfunction.

Instrument and control functions

EAMU2991

- This ABS has a test mode which allows the owner to experience the pulsation at the brake levers when the ABS is operating. However, special tools are required, so please consult your Yamaha dealer.

ECA20100

NOTICE

3

Be careful not to damage the wheel sensor or wheel sensor rotor; otherwise, improper performance of the ABS will result.

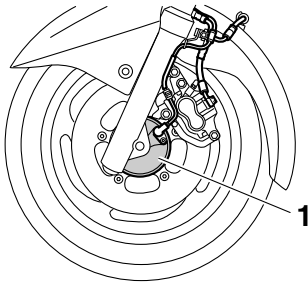

1. Front wheel hub

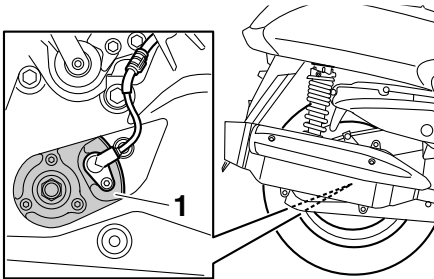

1. Rear wheel hub

Fuel tank cap

To open the fuel tank cap

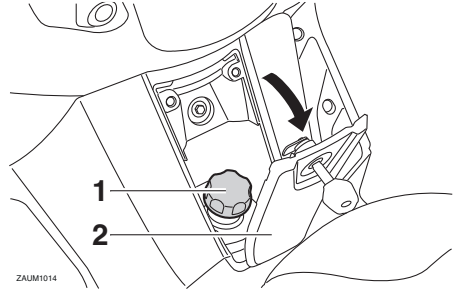

1. Fuel tank cap
2. Fuel tank cap cover

1. Insert the key into the lock and turn it counterclockwise. The lock will be released and the lid can be pulled open.
2. To remove the fuel tank cap, turn it counterclockwise and then pull it off.

To close the fuel tank cap

1. Place the fuel tank cap onto the fuel tank opening and turn the fuel tank cap clockwise.

EWA11092

WARNING

Make sure that the fuel tank cap is properly closed after filling fuel. Leaking fuel is a fire hazard.

2. Close the lid, turn the key clockwise to the original position, and then remove it.

Instrument and control functions

Fuel

Make sure there is sufficient gasoline in the tank.

EAU13222

EWA10882

WARNING

Gasoline and gasoline vapors are extremely flammable. To avoid fires and explosions and to reduce the risk of injury when refueling, follow these instructions.

1. Before refueling, turn off the engine and be sure that no one is sitting on the vehicle. Never refuel while smoking, or while in the vicinity of sparks, open flames, or other sources of ignition such as the pilot lights of water heaters and clothes dryers.
2. Do not overfill the fuel tank. When refueling, be sure to insert the pump nozzle into the fuel tank filler hole. Stop filling when the fuel reaches the bottom of the filler tube. Because fuel expands when it heats up, heat from the engine or the sun can cause fuel to spill out of the fuel tank.

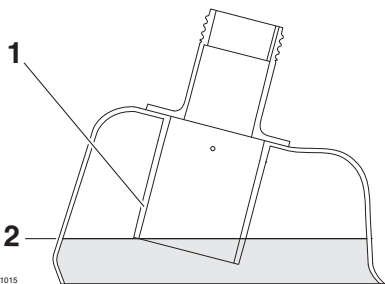

ZAUM1015

1. Fuel tank filler tube
2. Maximum fuel level

3. Wipe up any spilled fuel immediately. **NOTICE:** Immediately wipe off spilled fuel with a clean, dry, soft cloth, since fuel may deteriorate painted surfaces or plastic parts. [ECA10072]
4. Be sure to securely close the fuel tank cap.

EWA15152

WARNING

Gasoline is poisonous and can cause injury or death. Handle gasoline with care. Never siphon gasoline by mouth. If you should swallow some gasoline or inhale a lot of gasoline vapor, or get some gasoline in your eyes, see your doctor immediately. If gasoline spills on your skin, wash with soap and water. If gasoline spills on your clothing, change your clothes.

EAU54602

Recommended fuel:

Premium unleaded gasoline (Gasohol (E10) acceptable)

Fuel tank capacity:

13.2 L (3.48 US gal, 2.90 Imp.gal)

Fuel reserve amount (when the fuel level warning light comes on):

2.5 L (0.66 US gal, 0.55 Imp.gal)

ECA11401

NOTICE

Use only unleaded gasoline. The use of leaded gasoline will cause severe damage to internal engine parts, such as the valves and piston rings, as well as to the exhaust system.

Your Yamaha engine has been designed to use premium unleaded gasoline with a research octane number of

Instrument and control functions

95 or higher. If knocking (or pinging) occurs, use a gasoline of a different brand. Use of unleaded fuel will extend spark plug life and reduce maintenance costs.

Gasohol

There are two types of gasohol: gasohol containing ethanol and that containing methanol. Gasohol containing ethanol can be used if the ethanol content does not exceed 10% (E10). Gasohol containing methanol is not recommended by Yamaha because it can cause damage to the fuel system or vehicle performance problems.

EAU13447

Catalytic converters

This vehicle is equipped with catalytic converters in the exhaust system.

EWA10863

WARNING

The exhaust system is hot after operation. To prevent a fire hazard or burns:

- **Do not park the vehicle near possible fire hazards such as grass or other materials that easily burn.**
- **Park the vehicle in a place where pedestrians or children are not likely to touch the hot exhaust system.**
- **Make sure that the exhaust system has cooled down before doing any maintenance work.**
- **Do not allow the engine to idle more than a few minutes. Long idling can cause a build-up of heat.**

ECA10702

NOTICE

Use only unleaded gasoline. The use of leaded gasoline will cause unreparable damage to the catalytic converter.

Instrument and control functions

EAU13933

Seat

TIP _____

Make sure that the seat is properly secured before riding.

To open the seat

1. Place the scooter on the center-stand.
2. Insert the key into the main switch, and then turn it counterclockwise to “OPEN”.

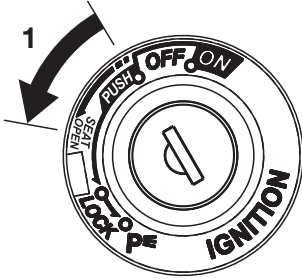

1. Open.

TIP _____

Do not push inward when turning the key.

3. Fold the seat up.

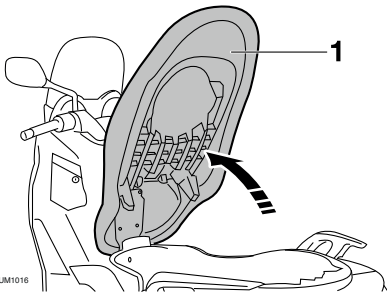

1. Seat open position

To close the seat

1. Fold the seat down, and then push it down to lock it in place.
2. Remove the key from the main switch if the scooter will be left unattended.

Instrument and control functions

Storage compartments

EAUM3002

Front storage compartment A

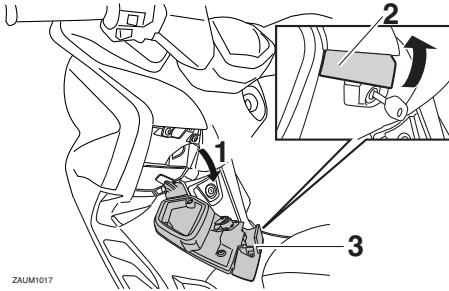

ZAUM1017

1. Open.
2. Storage compartment opening lever
3. Lid

To open the storage compartment when it is locked, insert the key into the lock, turn it clockwise, and then pull on the lever.

To open the storage compartment when it is unlocked, simply pull on the lever.

To lock the storage compartment, push the lid into the original position, insert the key into the lock, turn it counterclockwise, and then remove it.

Front storage compartment B

To open the storage compartment, pull on the lever.

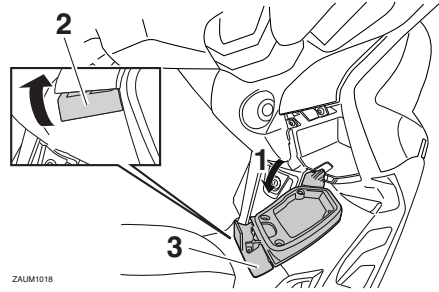

ZAUM1018

1. Open.
2. Storage compartment opening lever
3. Lid

To close the storage compartment, push the lid into the original position. **WARNING! Do not store heavy items in this compartment.** [EWA11162]

Rear storage compartment

Two helmets can be stored in the storage compartment under the seat. (See page 3-19.)

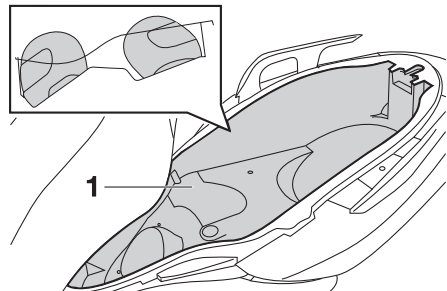

1. Rear storage compartment

ECA10082

NOTICE

Keep the following points in mind when using the storage compartment.

- Since the storage compartment accumulates heat when exposed to the sun and/or the engine heat, do not store anything

susceptible to heat, consumables or flammable items inside it.

- To avoid humidity from spreading through the storage compartment, wrap wet articles in a plastic bag before storing them in the compartment.
- Since the storage compartment may get wet while the scooter is being washed, wrap any articles stored in the compartment in a plastic bag.
- Do not keep anything valuable or breakable in the storage compartment.

EAU14893

Adjusting the shock absorber assemblies

EAU10211



Always adjust both shock absorber assemblies equally, otherwise poor handling and loss of stability may result.

Each shock absorber assembly is equipped with a spring preload adjusting ring.

ECA10102

NOTICE

To avoid damaging the mechanism, do not attempt to turn beyond the maximum or minimum settings.

 **WARNING**

EWA16121

Do not exceed the following loading limits:

- Front storage compartment A: 1 kg (2.2 lb)
- Front storage compartment B: 1 kg (2.2 lb)
- Rear storage compartment: 5 kg (11 lb)
- Maximum load for the vehicle: 181 kg (399 lb)

Adjust the spring preload as follows.

To increase the spring preload and thereby harden the suspension, turn the adjusting ring on each shock absorber assembly in direction (a). To decrease the spring preload and thereby soften the suspension, turn the adjusting ring on each shock absorber assembly in direction (b).

- Align the appropriate notch in the adjusting ring with the position indicator on the shock absorber.
- Use the spring preload adjusting tool included in the owner's tool kit to make this adjustment.

Instrument and control functions

EAU15306

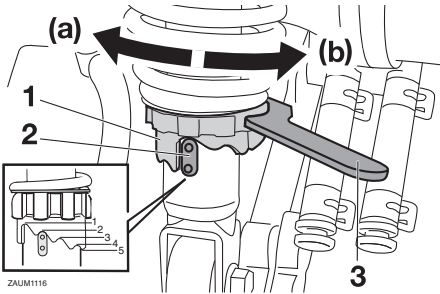

1. Position indicator
2. Spring preload adjusting ring
3. Spring preload adjusting tool

Spring preload setting:

Minimum (soft):

1

Standard:

2

Maximum (hard):

5

Sidestand

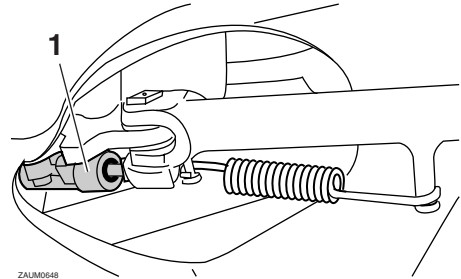

1. Sidestand switch

The sidestand is located on the left side of the frame. Raise the sidestand or lower it with your foot while holding the vehicle upright.

TIP

The built-in sidestand switch is part of the ignition circuit cut-off system, which cuts the ignition in certain situations. (See the following section for an explanation of the ignition circuit cut-off system.)

EWA10242

WARNING

The vehicle must not be ridden with the sidestand down, or if the sidestand cannot be properly moved up (or does not stay up), otherwise the sidestand could contact the ground and distract the operator, resulting in a possible loss of control. Yamaha's ignition circuit cut-off system has been designed to assist the operator in fulfilling the responsibility of raising the sidestand before starting off. Therefore, check this system regularly and have a Yamaha dealer repair it if it does not function properly.

Ignition circuit cut-off system

The ignition circuit cut-off system (comprising the sidestand switch and brake light switches) has the following functions.

- It prevents starting when the sidestand is up, but neither brake is applied.
- It prevents starting when either brake is applied, but the sidestand is still down.
- It cuts the running engine when the sidestand is moved down.

Periodically check the operation of the ignition circuit cut-off system according to the following procedure.

Instrument and control functions

3



WARNING

- The vehicle must be placed on the centerstand during this inspection.
- If a malfunction is noted, have a Yamaha dealer check the system before riding.

With the engine turned off:
1. Move the sidestand down.
2. Turn the key on.
3. Keep the front or rear brake applied.
4. Push the start switch.
Does the engine start?

NO

YES

The sidestand switch may not be working correctly.
The scooter should not be ridden until checked by a Yamaha dealer.

With the engine still off:
5. Move the sidestand up.
6. Keep the front or rear brake applied.
7. Push the start switch.
Does the engine start?

YES

NO

The brake switch may not be working correctly.
The scooter should not be ridden until checked by a Yamaha dealer.

With the engine still running:
8. Move the sidestand down.
Does the engine stall?

YES

NO

The sidestand switch may not be working correctly.
The scooter should not be ridden until checked by a Yamaha dealer.

The system is OK. **The scooter can be ridden.**

For your safety – pre-operation checks

EAU63440

Inspect your vehicle each time you use it to make sure the vehicle is in safe operating condition. Always follow the inspection and maintenance procedures and schedules described in the Owner's Manual.

EWA11152

WARNING

Failure to inspect or maintain the vehicle properly increases the possibility of an accident or equipment damage. Do not operate the vehicle if you find any problem. If a problem cannot be corrected by the procedures provided in this manual, have the vehicle inspected by a Yamaha dealer.

Before using this vehicle, check the following points:

ITEM	CHECKS	PAGE
Fuel	<ul style="list-style-type: none">• Check fuel level in fuel tank.• Refuel if necessary.• Check fuel line for leakage.	3-17
Engine oil	<ul style="list-style-type: none">• Check oil level in engine.• If necessary, add recommended oil to specified level.• Check vehicle for oil leakage.	6-10
Final transmission oil	<ul style="list-style-type: none">• Check vehicle for oil leakage.	6-13
Coolant	<ul style="list-style-type: none">• Check coolant level in reservoir.• If necessary, add recommended coolant to specified level.• Check cooling system for leakage.	6-14
Front brake	<ul style="list-style-type: none">• Check operation.• If soft or spongy, have Yamaha dealer bleed hydraulic system.• Check brake pads for wear.• Replace if necessary.• Check fluid level in reservoir.• If necessary, add specified brake fluid to specified level.• Check hydraulic system for leakage.	6-20, 6-21, 6-22
Rear brake	<ul style="list-style-type: none">• Check operation.• If soft or spongy, have Yamaha dealer bleed hydraulic system.• Check brake pads for wear.• Replace if necessary.• Check fluid level in reservoir.• If necessary, add specified brake fluid to specified level.• Check hydraulic system for leakage.	6-20, 6-21, 6-22
Throttle grip	<ul style="list-style-type: none">• Make sure that operation is smooth.• Check throttle grip free play.• If necessary, have Yamaha dealer adjust throttle grip free play and lubricate cable and grip housing.	6-17, 6-24

For your safety – pre-operation checks

ITEM	CHECKS	PAGE
Wheels and tires	<ul style="list-style-type: none">• Check for damage.• Check tire condition and tread depth.• Check air pressure.• Correct if necessary.	6-18, 6-20
Brake levers	<ul style="list-style-type: none">• Make sure that operation is smooth.• Lubricate lever pivoting points if necessary.	6-25
Centerstand, side-stand	<ul style="list-style-type: none">• Make sure that operation is smooth.• Lubricate pivots if necessary.	6-25
Chassis fasteners	<ul style="list-style-type: none">• Make sure that all nuts, bolts and screws are properly tightened.• Tighten if necessary.	—
Instruments, lights, signals and switches	<ul style="list-style-type: none">• Check operation.• Correct if necessary.	—
Sidestand switch	<ul style="list-style-type: none">• Check operation of ignition circuit cut-off system.• If system is not working correctly, have Yamaha dealer check vehicle.	3-22

Operation and important riding points

EAU15952

EAU45311

Read the Owner's Manual carefully to become familiar with all controls. If there is a control or function you do not understand, ask your Yamaha dealer.

EWA10272

WARNING

Failure to familiarize yourself with the controls can lead to loss of control, which could cause an accident or injury.

TIP

This model is equipped with a lean angle sensor to stop the engine in case of a turnover. To start the engine after a turnover, be sure to turn the main switch to "OFF" and then to "ON". Failing to do so will prevent the engine from starting even though the engine will crank when pushing the start switch.

Operation and important riding points

Starting the engine

EAUM3850

ECA10251

NOTICE

See page 5-5 for engine break-in instructions prior to operating the vehicle for the first time.

In order for the ignition circuit cut-off system to enable starting, the side-stand must be up.

See page 3-23 for more information.

1. Turn the key to "ON".

The following warning light, indicator light and indicators should come on for a few seconds, then go off.

- Engine trouble warning light
- Immobilizer system indicator light
- V-belt replacement indicator
- Oil change indicator
- Fuel level warning light

ECA11834

NOTICE

If a warning or indicator light does not come on initially when the key is turned to "ON", or if a warning or indicator light remains on, see page 3-4 for the corresponding warning and indicator light circuit check.

The ABS warning light should come on when the main switch is turned to "ON" and then go off after traveling at a speed of 10 km/h (6 mi/h) or higher.

ECA17682

NOTICE

If the ABS warning light does not come on and then go off as explained above, see page 3-4 for the warning light circuit check.

2. Close the throttle completely.
3. Start the engine by pushing the start switch while applying the front or rear brake.

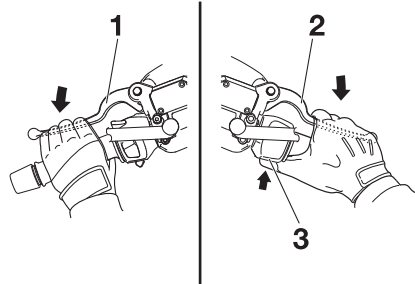

1. Rear brake lever
2. Front brake lever
3. Start switch

If the engine does not start, release the start switch, wait a few seconds, and then try again. Each starting attempt should be as short as possible to preserve the battery. Do not crank the engine more than 10 seconds on any one attempt.

ECA11043

NOTICE

For maximum engine life, never accelerate hard when the engine is cold!

Operation and important riding points

EAU45093

EAU16782

Starting off

1. While pulling the rear brake lever with your left hand and holding the grab bar with your right hand, push the scooter off the center-stand.

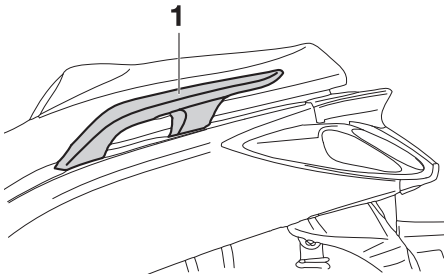

1. Grab bar

2. Sit astride the seat, and then adjust the rear view mirrors.
3. Switch the turn signals on.
4. Check for oncoming traffic, and then slowly turn the throttle grip (on the right) in order to take off.
5. Switch the turn signals off.

Acceleration and deceleration

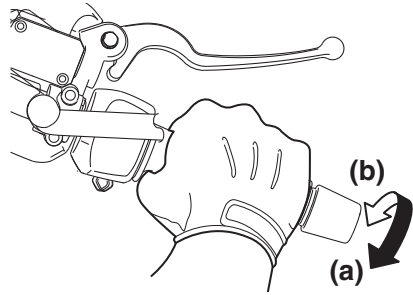

The speed can be adjusted by opening and closing the throttle. To increase the speed, turn the throttle grip in direction (a). To reduce the speed, turn the throttle grip in direction (b).

Operation and important riding points

Braking

EAU16794

EWA10301

WARNING

- Avoid braking hard or suddenly (especially when leaning over to one side), otherwise the scooter may skid or overturn.
- Railroad crossings, streetcar rails, iron plates on road construction sites, and manhole covers become extremely slippery when wet. Therefore, slow down when approaching such areas and cross them with caution.
- Keep in mind that braking on a wet road is much more difficult.
- Ride slowly down a hill, as braking downhill can be very difficult.

1. Close the throttle completely.
2. Apply both front and rear brakes simultaneously while gradually increasing the pressure.

Front

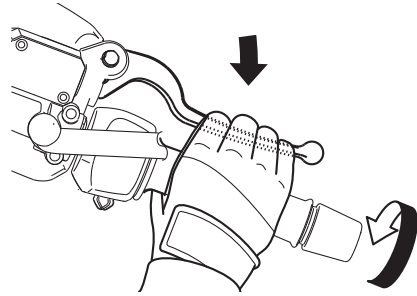

Rear

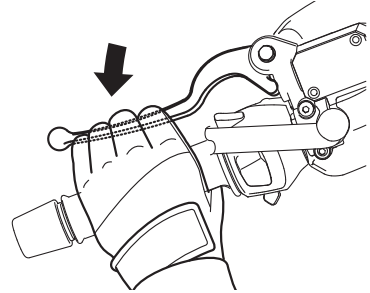

EAU16821

Tips for reducing fuel consumption

Fuel consumption depends largely on your riding style. Consider the following tips to reduce fuel consumption:

- Avoid high engine speeds during acceleration.
- Avoid high engine speeds with no load on the engine.
- Turn the engine off instead of letting it idle for an extended length of time (e.g., in traffic jams, at traffic lights or at railroad crossings).

EAU16831

Engine break-in

There is never a more important period in the life of your engine than the period between 0 and 1000 km (600 mi). For this reason, you should read the following material carefully.

Since the engine is brand new, do not put an excessive load on it for the first 1000 km (600 mi). The various parts in the engine wear and polish themselves to the correct operating clearances. During this period, prolonged full-throttle operation or any condition that might result in engine overheating must be avoided.

EAUS1841

0–500 km (0–300 mi)

Avoid prolonged operation above 5000 r/min.

500–1000 km (300–600 mi)

Avoid prolonged operation above 7500 r/min. **NOTICE: After 1000 km (600 mi) of operation, be sure to replace the engine oil, final transmission oil and the oil filter element.** [ECA12932]

1000 km (600 mi) and beyond

The vehicle can now be operated normally.

ECA10311

NOTICE

- Keep the engine speed out of the tachometer red zone.
- If any engine trouble should occur during the engine break-in period, immediately have a Yamaha dealer check the vehicle.

Operation and important riding points

EAU17214

Parking

When parking, stop the engine, and then remove the key from the main switch.

EWA10312

WARNING

- Since the engine and exhaust system can become very hot, park in a place where pedestrians or children are not likely to touch them and be burned.
 - Do not park on a slope or on soft ground, otherwise the vehicle may overturn, increasing the risk of a fuel leak and fire.
 - Do not park near grass or other flammable materials which might catch fire.
-

Periodic maintenance and adjustment

EAUS1824

Periodic inspection, adjustment, and lubrication will keep your vehicle in the safest and most efficient condition possible. Safety is an obligation of the vehicle owner/operator. The most important points of vehicle inspection, adjustment, and lubrication are explained on the following pages.

The intervals given in the periodic maintenance charts should be simply considered as a general guide under normal riding conditions. However, depending on the weather, terrain, geographical location, and individual use, the maintenance intervals may need to be shortened.

EWA10322

WARNING

Failure to properly maintain the vehicle or performing maintenance activities incorrectly may increase your risk of injury or death during service or while using the vehicle. If you are not familiar with vehicle service, have a Yamaha dealer perform service.

EWA15123

WARNING

Turn off the engine when performing maintenance unless otherwise specified.

- A running engine has moving parts that can catch on body parts or clothing and electrical parts that can cause shocks or fires.
- Running the engine while servicing can lead to eye injury, burns, fire, or carbon monoxide poisoning – possibly leading to

death. See page 1-2 for more information about carbon monoxide.

EWA10331

WARNING

This scooter is designed for use on paved roads only. If this scooter is operated in abnormally dusty, muddy or wet conditions, the air filter element should be cleaned or replaced more frequently, otherwise rapid engine wear may result. Consult a Yamaha dealer for proper maintenance intervals.

EWA15461

WARNING

Brake discs, calipers, drums, and linings can become very hot during use. To avoid possible burns, let brake components cool before touching them.

Periodic maintenance and adjustment

EAU17303

EAU17382

Emission controls not only function to ensure cleaner air, but are also vital to proper engine operation and maximum performance. In the following periodic maintenance charts, the services related to emissions control are grouped separately. These services require specialized data, knowledge, and equipment. Maintenance, replacement, or repair of the emission control devices and systems may be performed by any repair establishment or individual that is certified (if applicable). Yamaha dealers are trained and equipped to perform these particular services.

Owner's tool kit

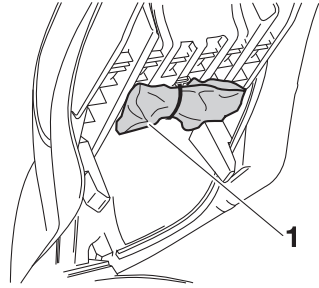

ZAUJ1020

1. Owner's tool kit

The owner's tool kit is located under the seat. (See page 3-19.)

The service information included in this manual and the tools provided in the owner's tool kit are intended to assist you in the performance of preventive maintenance and minor repairs. However, additional tools such as a torque wrench may be necessary to perform certain maintenance work correctly.

TIP

If you do not have the tools or experience required for a particular job, have a Yamaha dealer perform it for you.

Periodic maintenance and adjustment

EAU71020

TIP

- The annual checks must be performed every year, except if a kilometer-based maintenance, or for the UK, a mileage-based maintenance, is performed instead.
- From 30000 km (17500 mi), repeat the maintenance intervals starting from 6000 km (3500 mi).
- Items marked with an asterisk should be performed by a Yamaha dealer as they require special tools, data and technical skills.

EAU71060

Periodic maintenance chart for the emission control system

NO.	ITEM	CHECK OR MAINTENANCE JOB	ODOMETER READING					ANNUAL CHECK		
			X 1000 km							
			1	6	12	18	24			
X 1000 mi					0.6	3.5	7	10.5	14	
1	* Fuel line	<ul style="list-style-type: none"> • Check fuel hoses for cracks or damage. • Replace if necessary. 		√	√	√	√	√	√	√
2	* Spark plug	<ul style="list-style-type: none"> • Check condition. • Adjust gap and clean. 		√		√				
		<ul style="list-style-type: none"> • Replace. 			√		√			
3	* Valve clearance	<ul style="list-style-type: none"> • Check and adjust. 		√	√	√	√	√		
4	* Fuel injection	<ul style="list-style-type: none"> • Check engine idle speed. 	√	√	√	√	√	√	√	√
5	* Exhaust system	<ul style="list-style-type: none"> • Check for leakage. • Tighten if necessary. • Replace gasket if necessary. 	√	√	√	√	√	√		

Periodic maintenance and adjustment

EAU71361

General maintenance and lubrication chart

NO.	ITEM	CHECK OR MAINTENANCE JOB	ODOMETER READING					ANNUAL CHECK			
			X 1000 km								
			1	6	12	18	24				
X 1000 mi					0.6	3.5	7	10.5	14		
1	* Diagnostic system check	<ul style="list-style-type: none"> Perform dynamic inspection using Yamaha diagnostic tool. Check the error codes. 	√	√	√	√	√	√	√	√	
2	* Air filter element	<ul style="list-style-type: none"> Replace. 			√			√			
3	Air filter case check hose	<ul style="list-style-type: none"> Clean. 	√	√	√	√	√	√	√		
4	* V-belt case air filter element	<ul style="list-style-type: none"> Clean. Replace if necessary. 		√	√	√	√	√	√	√	
5	* Front brake	<ul style="list-style-type: none"> Check operation, fluid level, and for fluid leakage. Replace brake pads if necessary. 	√	√	√	√	√	√	√	√	
6	* Rear brake	<ul style="list-style-type: none"> Check operation, fluid level, and for fluid leakage. Replace brake pads if necessary. 	√	√	√	√	√	√	√	√	
7	* Brake hoses	<ul style="list-style-type: none"> Check for cracks or damage. Replace. 		√	√	√	√	√	√	√	
8	* Brake fluid	<ul style="list-style-type: none"> Change. 	Every 4 years								
9	* Wheels	<ul style="list-style-type: none"> Check runout and for damage. Replace if necessary. 		√	√	√	√	√	√		
10	* Tires	<ul style="list-style-type: none"> Check tread depth and for damage. Replace if necessary. Check air pressure. Correct if necessary. 		√	√	√	√	√	√	√	
11	* Wheel bearings	<ul style="list-style-type: none"> Check bearing for looseness or damage. 		√	√	√	√	√	√		
12	* Steering bearings	<ul style="list-style-type: none"> Check bearing assemblies for looseness. 	√	√	√	√					
		<ul style="list-style-type: none"> Moderately repack with lithium-soap-based grease. 						√			
13	* Chassis fasteners	<ul style="list-style-type: none"> Make sure that all nuts, bolts and screws are properly tightened. 		√	√	√	√	√	√	√	

Periodic maintenance and adjustment

NO.	ITEM	CHECK OR MAINTENANCE JOB	ODOMETER READING					ANNUAL CHECK	
			X 1000 km						
			1	6	12	18	24		
X 1000 mi					0.6	3.5	7	10.5	14
14	Front brake lever pivot shaft	<ul style="list-style-type: none"> Lubricate with silicone grease. 	√	√	√	√	√	√	
15	Rear brake lever pivot shaft	<ul style="list-style-type: none"> Lubricate with silicone grease. 	√	√	√	√	√	√	
16	Sidestand, center-stand	<ul style="list-style-type: none"> Check operation. Lubricate with lithium-soap-based grease. 	√	√	√	√	√	√	
17	* Sidestand switch	<ul style="list-style-type: none"> Check operation and replace if necessary. 	√	√	√	√	√	√	
18	* Front fork	<ul style="list-style-type: none"> Check operation and for oil leakage. Replace if necessary. 	√	√	√	√	√	√	
19	* Shock absorber assemblies	<ul style="list-style-type: none"> Check operation and for oil leakage. Replace if necessary. 	√	√	√	√	√	√	
20	Engine oil	<ul style="list-style-type: none"> Change (warm engine before draining). 	At the initial interval and when the oil change indicator flashes or comes on						
		<ul style="list-style-type: none"> Check oil level and vehicle for oil leakage. 	Every 3000 km (1800 mi)						
21	Engine oil filter element	<ul style="list-style-type: none"> Replace. 	√	√	√	√	√	√	
22	* Final transmission oil	<ul style="list-style-type: none"> Check vehicle for oil leakage. Change. 	√	√	√	√	√	√	
23	* Cooling system	<ul style="list-style-type: none"> Check coolant level and vehicle for coolant leakage. Change. 	√	√	√	√	√	√	
24	* V-belt	<ul style="list-style-type: none"> Replace. 	When the V-belt replacement indicator flashes [every 18000 km (10500 mi)]						
25	* Front and rear brake switches	<ul style="list-style-type: none"> Check operation. 	√	√	√	√	√	√	
26	* Moving parts and cables	<ul style="list-style-type: none"> Lubricate. 	√	√	√	√	√	√	

Periodic maintenance and adjustment

NO.	ITEM	CHECK OR MAINTENANCE JOB	ODOMETER READING					ANNUAL CHECK		
			X 1000 km							
			1	6	12	18	24			
X 1000 mi					0.6	3.5	7	10.5	14	
27	* Throttle grip housing and cable	<ul style="list-style-type: none"> • Check operation and free play. • Adjust the throttle cable free play if necessary. • Lubricate the throttle grip housing and cable. 		√	√	√	√	√		
28	* Lights, signals and switches	<ul style="list-style-type: none"> • Check operation. • Adjust headlight beam. 	√	√	√	√	√	√		

EAU72780

TIP

6

- Engine air filter and V-belt air filters
 - This model's engine air filter is equipped with a disposable oil-coated paper element, which must not be cleaned with compressed air to avoid damaging it.
 - The engine air filter element needs to be replaced and the V-belt air filter elements need to be serviced more frequently when riding in unusually wet or dusty areas.
- Hydraulic brake service
 - After disassembling the brake master cylinders and calipers, always change the fluid. Regularly check the brake fluid levels and fill the reservoirs as required.
 - Every two years replace the internal components of the brake master cylinders and calipers, and change the brake fluid.
 - Replace the brake hoses every four years and if cracked or damaged.

Periodic maintenance and adjustment

EAU18773

Removing and installing panels

The panels shown need to be removed to perform some of the maintenance jobs described in this chapter. Refer to this section each time a panel needs to be removed and installed.

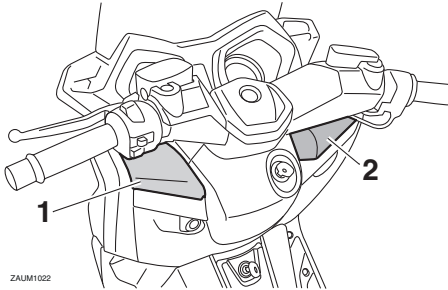

ZAUM1022

1. Panel A
2. Panel B

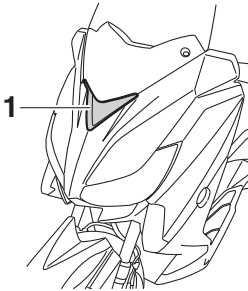

ZAUM1021

1. Panel C

EAUM3340

Panel A

To remove the panel

1. Open the front storage compartment A. (See page 3-20.)
2. Remove the screw, and then pull the panel off.

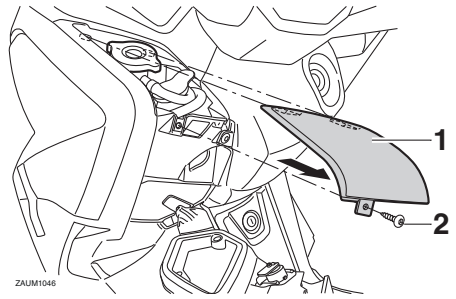

ZAUM1046

1. Panel A
2. Screw

To install the panel

Place the panel in the original position, and then install the screw.

Panel B

To remove the panel

1. Open the front storage compartment B. (See page 3-20.)
2. Remove the screw, and then pull the panel off.

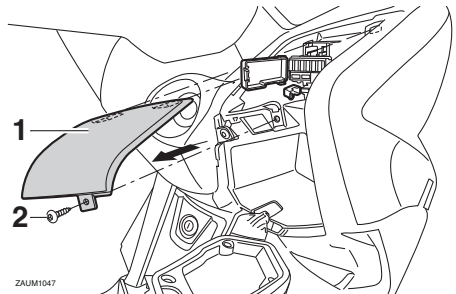

ZAUM1047

1. Panel B
2. Screw

To install the panel

Place the panel in the original position, and then install the screw.

Periodic maintenance and adjustment

Panel C

To remove the panel

1. Remove the quick fastener, and then pull the under cowling off as shown.

TIP

The quick fastener is removed by pushing the center pin in with a screwdriver, and then pulling the fastener out.

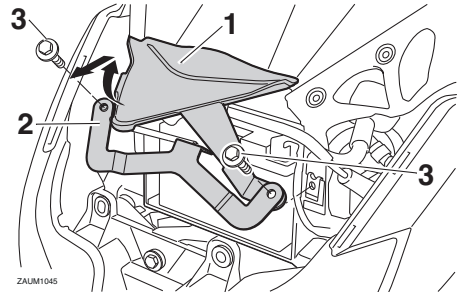

1. Panel C
2. Bracket
3. Bolt

To install the panel

1. Place the battery bracket and panel assembly in the original position, and then install the bolts.
2. Place the cowling in the original position, and then install the screws.
3. Place the under cowling in the original position, and then install the quick fastener.

TIP

To install the quick fastener, push the center pin out so that it will protrude from the fastener head, insert the fastener into the under cowling, and then push the protruding pin in until it is flush with the fastener head.

6



1. Cowling
2. Quick fastener (after removal)

2. Remove the cowling screws, and then pull it off.

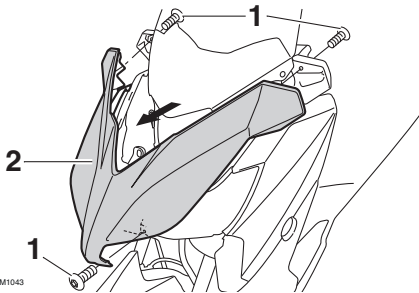

1. Screw
2. Cowling

3. Remove the battery bracket bolts, and then pull it off.
4. Remove the battery bracket and panel assembly by pulling it off as shown.

Periodic maintenance and adjustment

EAUM3360

Checking the spark plug

The spark plug is an important engine component, which is easy to check. Since heat and deposits will cause any spark plug to slowly erode, the spark plug should be removed and checked in accordance with the periodic maintenance and lubrication chart. In addition, the condition of the spark plug can reveal the condition of the engine.

To remove the spark plug

1. Place the vehicle on the center-stand
2. Open the seat. (See page 3-19.)
3. Remove the rear storage compartment by removing the bolts.

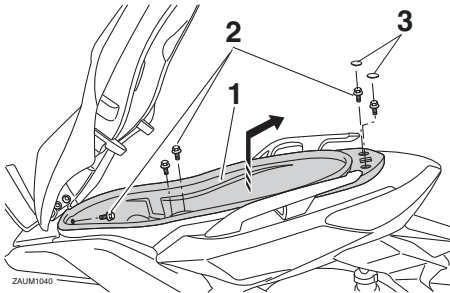

1. Storage compartment
2. Bolt
3. Rubber cap

4. Remove the spark plug cap.

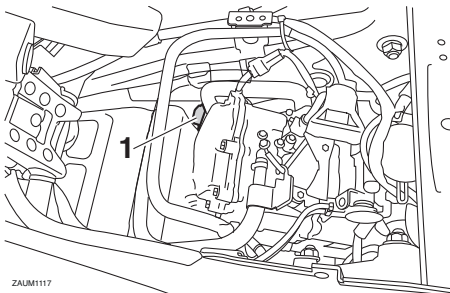

1. Spark plug cap

5. Remove the spark plug as shown, with the spark plug wrench included in the owner's tool kit.

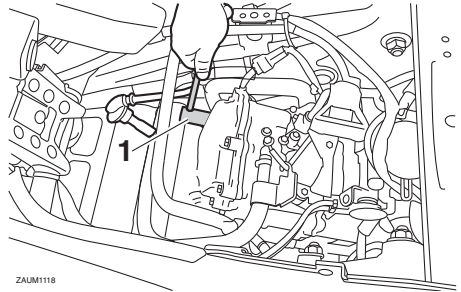

1. Spark plug wrench

To check the spark plug

1. Check that the porcelain insulator around the center electrode of the spark plug is a medium-to-light tan (the ideal color when the vehicle is ridden normally).

TIP

If the spark plug shows a distinctly different color, the engine could be operating improperly. Do not attempt to diagnose such problems yourself. Instead, have a Yamaha dealer check the vehicle.

2. Check the spark plug for electrode erosion and excessive carbon or other deposits, and replace it if necessary.

Specified spark plug: NGK/CR9E

3. Measure the spark plug gap with a wire thickness gauge and, if necessary, adjust the gap to specification.

Periodic maintenance and adjustment

EAUM3332

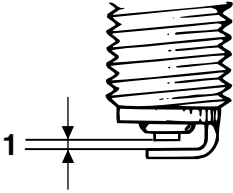

1. Spark plug gap

Spark plug gap:
0.7–0.8 mm (0.028–0.031 in)

To install the spark plug

1. Clean the surface of the spark plug gasket and its mating surface, and then wipe off any grime from the spark plug threads.
2. Install the spark plug with the spark plug wrench, and then tighten it to the specified torque.

Tightening torque:
Spark plug:
12.5 N·m (1.25 kgf·m, 9.04 lb·ft)

TIP

If a torque wrench is not available when installing a spark plug, a good estimate of the correct torque is 1/4–1/2 turn past finger tight. However, the spark plug should be tightened to the specified torque as soon as possible.

3. Install the spark plug cap.
4. Place the rear storage compartment in the original position and install the bolts.
5. Close the seat.

Engine oil

The engine oil level should be checked before each ride. In addition, the oil must be changed at the intervals specified in the periodic maintenance and lubrication chart and when the service indicator light comes on.

To check the engine oil level

1. Place the scooter on the center-stand. A slight tilt to the side can result in a false reading.
2. Start the engine, warm it up for several minutes, and then turn it off.
3. Wait a few minutes until the oil settles, remove the oil filler cap, wipe the dipstick clean, insert it back into the oil filler hole (without screwing it in), and then remove it again to check the oil level.

TIP

The engine oil should be between the minimum and maximum level marks.

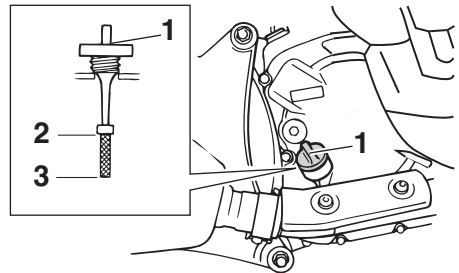

ZAJM0685

1. Engine oil filler cap
2. Maximum level mark
3. Minimum level mark
4. If the engine oil is below the minimum level mark, add sufficient oil of the recommended type to raise it to the correct level.

Periodic maintenance and adjustment

5. Insert the dipstick into the oil filler hole, and then tighten the oil filler cap.

To change the engine oil (with or without oil filter element replacement)

1. Start the engine, warm it up for several minutes, and then turn it off.
2. Place an oil pan under the engine to collect the used oil.
3. Remove the engine oil filler cap and the engine oil drain bolt to drain the oil from the crankcase.

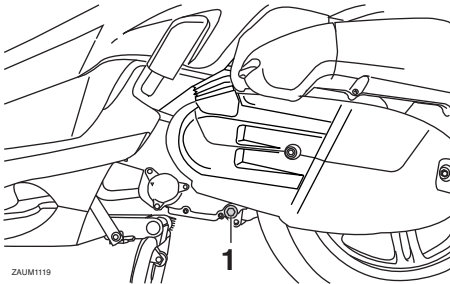

ZAJM1119

1. Engine oil drain bolt

4. Check the drain bolt washer for damage and replace it if necessary.

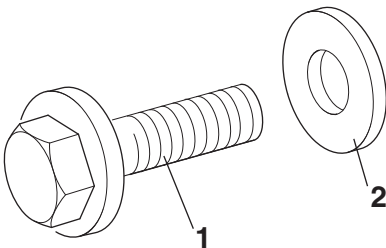

ZAJM0129

1. Engine oil drain bolt
2. Washer

TIP

Skip steps 5–9 if the oil filter element is not being replaced.

5. Remove the oil filter element cover by removing the bolts.

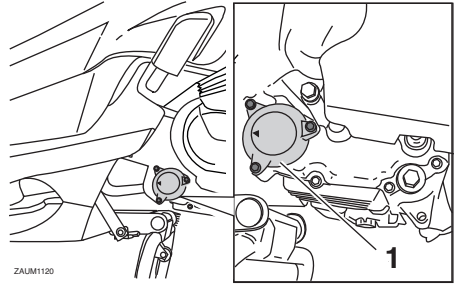

ZAJM1120

1. Oil filter element cover

6. Remove the oil filter element and O-ring.

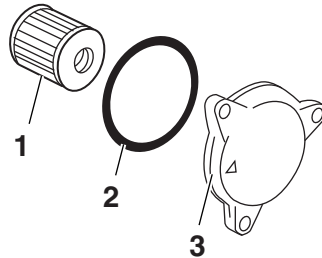

ZAJM0712

1. Oil filter element
2. O-ring
3. Oil filter element cover

7. Check the O-ring for damage and replace it if necessary.
8. Install the new oil filter element and an O-ring.
9. Install the oil filter element cover by installing the bolts, then tightening them to the specified torque.

Periodic maintenance and adjustment

Tightening torque:

Oil filter cover bolt:
10 N·m (1.0 kgf·m, 7.2 lb·ft)

TIP

Make sure that the O-ring is properly seated.

10. Install the washer and the engine oil drain bolt, and then tighten the drain bolt to the specified torque.

Tightening torque:

Engine oil drain bolt:
20 N·m (2.0 kgf·m, 14 lb·ft)

TIP

Make sure that the washer is properly seated.

11. Refill with the specified amount of the recommended engine oil, and then install and tighten the oil filler cap.

Recommended engine oil:

See page 8-1.

Oil change quantity:

Without oil filter element replacement:

1.40 L (1.48 US qt, 1.23 Imp.qt)

With oil filter element replacement:

1.50 L (1.59 US qt, 1.32 Imp.qt)

TIP

Be sure to wipe off spilled oil on any parts after the engine and exhaust system have cooled down.

ECA11671

NOTICE

- Do not use oils with a diesel specification of "CD" or oils of a higher quality than specified. In

addition, do not use oils labeled "ENERGY CONSERVING II" or higher.

- Be sure no foreign material enters the crankcase.

12. Start the engine, and then let it idle for several minutes while checking it for oil leakage. If oil is leaking, immediately turn the engine off and check for the cause.
13. Turn the engine off, and then check the oil level and correct it if necessary.
14. Reset the oil change indicator. (See page 3-8.)

Periodic maintenance and adjustment

EAU20067

Final transmission oil

The final transmission case must be checked for oil leakage before each ride. If any leakage is found, have a Yamaha dealer check and repair the scooter. In addition, the final transmission oil must be changed as follows at the intervals specified in the periodic maintenance and lubrication chart.

1. Start the engine, warm up the final transmission oil by riding the scooter for several minutes, and then stop the engine.
2. Place the scooter on the center-stand.
3. Place an oil pan under the final transmission case to collect the used oil.
4. Remove the final transmission oil filler cap and its O-ring from the final transmission case.

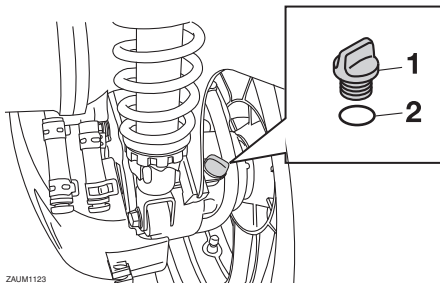

1. Final transmission oil filler cap
2. O-ring

5. Remove the final transmission oil drain bolt and its gasket to drain the oil from the final transmission case.

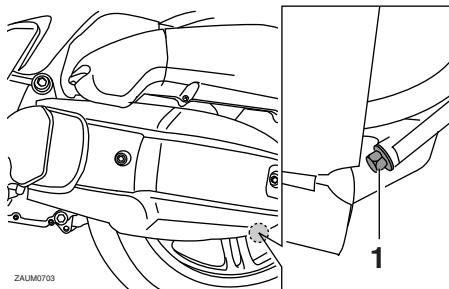

1. Final transmission oil drain bolt

6. Install the final transmission oil drain bolt and its new gasket, and then tighten the bolt to the specified torque.

Tightening torque:

Final transmission oil drain bolt:
20 N·m (2.0 kgf·m, 14 lb-ft)

7. Refill with the specified amount of the recommended final transmission oil. **WARNING! Make sure that no foreign material enters the final transmission case. Make sure that no oil gets on the tire or wheel.** [EWA11312]

Recommended final transmission oil:

See page 8-1.

Oil quantity:

0.21 L (0.22 US qt, 0.18 Imp.qt)

8. Install the final transmission oil filler cap and its new O-ring, and then tighten the oil filler cap.
9. Check the final transmission case for oil leakage. If oil is leaking, check for the cause.

Periodic maintenance and adjustment

Coolant

EAU20071

The coolant level should be checked before each ride. In addition, the coolant must be changed at the intervals specified in the periodic maintenance and lubrication chart.

To check the coolant level

EAM3045

1. Place the vehicle on a level surface and hold it in an upright position.
2. Open the front storage compartment A. (See page 3-20.)

TIP

- The coolant level must be checked on a cold engine since the level varies with engine temperature.
- Make sure that the vehicle is positioned straight up when checking the coolant level. A slight tilt to the side can result in a false reading.

3. Check the coolant level through the check window.

TIP

The coolant should be between the minimum and maximum level marks.

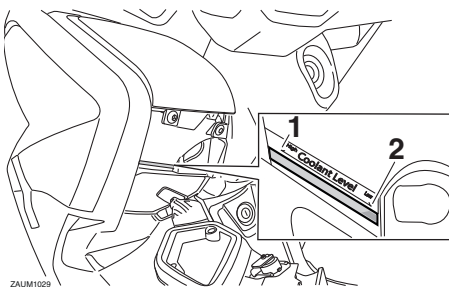

ZAUM1029

1. Maximum level mark
2. Minimum level mark

4. If the coolant is at or below the minimum level mark, remove panel A. (See page 6-7.)
5. Open the reservoir cap, and then add coolant to the maximum level mark. **WARNING! Remove only the coolant reservoir cap. Never attempt to remove the radiator cap when the engine is hot.**

[EWA15162] **NOTICE:** If coolant is not available, use distilled water or soft tap water instead. Do not use hard water or salt water since it is harmful to the engine. If water has been used instead of coolant, replace it with coolant as soon as possible, otherwise the cooling system will not be protected against frost and corrosion. If water has been added to the coolant, have a Yamaha dealer check the anti-freeze content of the coolant as soon as possible, otherwise the effectiveness of the coolant will be reduced. [ECA10473]

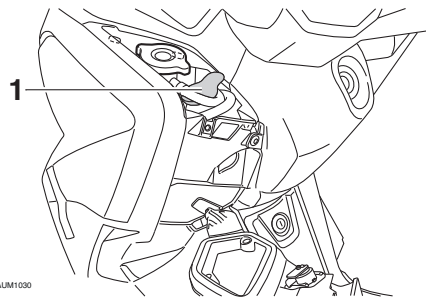

ZAUM1030

1. Coolant reservoir cap

Coolant reservoir capacity:
0.32 L (0.34 US qt, 0.28 Imp.qt)

6. Close the reservoir cap, and then install the panel.

Periodic maintenance and adjustment

7. Close the front storage compartment.

Changing the coolant

EAU33032

The coolant must be changed at the intervals specified in the periodic maintenance and lubrication chart. Have a Yamaha dealer change the coolant.

WARNING! Never attempt to remove the radiator cap when the engine is hot. [EWA10382]

EAUM3370

Air filter and V-belt case air filter elements and check hoses

The air filter element should be replaced and the V-belt case air filter element should be cleaned at the intervals specified in the periodic maintenance and lubrication chart. Service the air filter elements more frequently if you are riding in unusually wet or dusty areas.

Replacing the air filter element

1. Place the scooter on the center-stand.
2. Remove the air filter case cover by removing the screws.

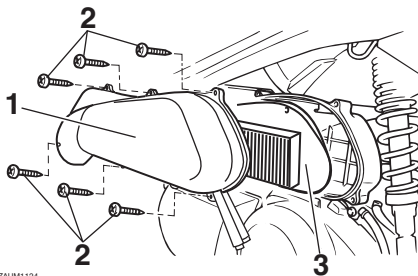

ZAJM1124

1. Air filter case cover
2. Screw
3. Air filter element

3. Pull the air filter element out.
4. Insert a new air filter element into the air filter case.
5. Install the air filter case cover by installing the screws.

To clean the air filter check hoses

1. Check the hoses at the bottom of air filter case for accumulated dirt or water.

Periodic maintenance and adjustment

Left

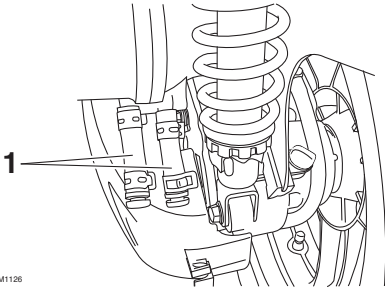

ZAUM1126

1. Air filter check hose
2. If dirt or water is visible, remove the hose, clean it, and then install it.

Cleaning the V-belt case air filter element

1. Remove the V-belt case air filter covers by removing the screws.

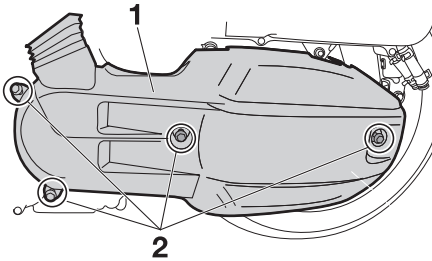

ZAUM1125

1. V-belt case air filter cover
2. Screw

2. Remove the air filter element, and then blow out the dirt with compressed air as shown.

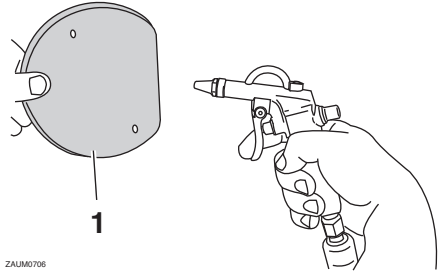

ZAUM0706

1. V-belt case air filter element
3. Check the air filter element for damage and replace it if necessary.
4. Install the air filter element with the colored side facing outward.
5. Install the V-belt case air filter covers by installing the screws.
NOTICE: Make sure that each filter element is properly seated in its case. The engine should never be operated without the filter elements installed, otherwise the piston(s) and/or cylinder(s) may become excessively worn. [ECA10532]

Periodic maintenance and adjustment

EAU21386

EAU21402

Checking the throttle grip free play

Measure the throttle grip free play as shown.

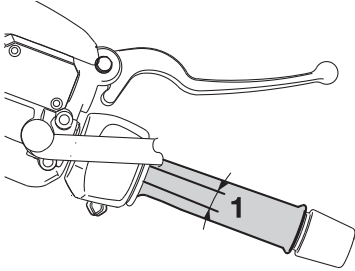

1. Throttle grip free play

Throttle grip free play:
3.0–5.0 mm (0.12–0.20 in)

Periodically check the throttle grip free play and, if necessary, have a Yamaha dealer adjust it.

Valve clearance

The valve clearance changes with use, resulting in improper air-fuel mixture and/or engine noise. To prevent this from occurring, the valve clearance must be adjusted by a Yamaha dealer at the intervals specified in the periodic maintenance and lubrication chart.

Periodic maintenance and adjustment

Tires

EAU61710

Tires are the only contact between the vehicle and the road. Safety in all conditions of riding depends on a relatively small area of road contact. Therefore, it is essential to maintain the tires in good condition at all times and replace them at the appropriate time with the specified tires.

Tire air pressure

The tire air pressure should be checked and, if necessary, adjusted before each ride.

EWA10504

WARNING

Operation of this vehicle with improper tire pressure may cause severe injury or death from loss of control.

- The tire air pressure must be checked and adjusted on cold tires (i.e., when the temperature of the tires equals the ambient temperature).
- The tire air pressure must be adjusted in accordance with the riding speed and with the total weight of rider, passenger, cargo, and accessories approved for this model.

Tire air pressure (measured on cold tires):

Up to 90 kg (198 lb) load:

Front:

190 kPa (1.90 kgf/cm², 28 psi)

Rear:

220 kPa (2.20 kgf/cm², 32 psi)

90 kg (198 lb) to maximum load:

Front:

210 kPa (2.10 kgf/cm², 30 psi)

Rear:

250 kPa (2.50 kgf/cm², 36 psi)

Maximum load*:

181 kg (399 lb)

* Total weight of rider, passenger, cargo and accessories

EWA10512

WARNING

Never overload your vehicle. Operation of an overloaded vehicle could cause an accident.

Tire inspection

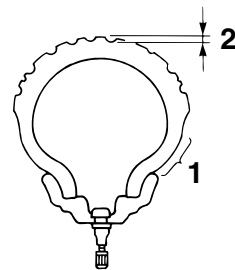

1. Tire sidewall
2. Tire tread depth

The tires must be checked before each ride. If the center tread depth reaches the specified limit, if the tire has a nail or glass fragments in it, or if the sidewall is cracked, have a Yamaha dealer replace the tire immediately.

Periodic maintenance and adjustment

EWA10462

Minimum tire tread depth (front and rear):

1.6 mm (0.06 in)

TIP

The tire tread depth limit may differ from country to country. Always comply with the local regulations.

EWA10472

! WARNING

- **Have a Yamaha dealer replace excessively worn tires. Besides being illegal, operating the vehicle with excessively worn tires decreases riding stability and can lead to loss of control.**
- **The replacement of all wheel and brake-related parts, including the tires, should be left to a Yamaha dealer, who has the necessary professional knowledge and experience to do so.**
- **Ride at moderate speeds after changing a tire since the tire surface must first be “broken in” for it to develop its optimal characteristics.**

! WARNING

The front and rear tires should be of the same make and design, otherwise the handling characteristics of the vehicle may be different, which could lead to an accident.

After extensive tests, only the tires listed below have been approved for this model by Yamaha.

Front tire:

Size:

120/70-15 M/C 56S(MICHELIN)

Manufacturer/model:

MICHELIN / CITYGRIP

Rear tire:

Size:

140/70-14 M/C 68S(MICHELIN)

Manufacturer/model:

MICHELIN / CITYGRIP

6

Tire information

This model is equipped with tubeless tires and tire air valves.

Tires age, even if they have not been used or have only been used occasionally. Cracking of the tread and sidewall rubber, sometimes accompanied by carcass deformation, is an evidence of ageing. Old and aged tires shall be checked by tire specialists to ascertain their suitability for further use.

Periodic maintenance and adjustment

EAU21963

EAU50861

Cast wheels

To maximize the performance, durability, and safe operation of your vehicle, note the following points regarding the specified wheels.

- The wheel rims should be checked for cracks, bends, warpage or other damage before each ride. If any damage is found, have a Yamaha dealer replace the wheel. Do not attempt even the smallest repair to the wheel. A deformed or cracked wheel must be replaced.
- The wheel should be balanced whenever either the tire or wheel has been changed or replaced. An unbalanced wheel can result in poor performance, adverse handling characteristics, and a shortened tire life.

Checking the front and rear brake lever free play

Front

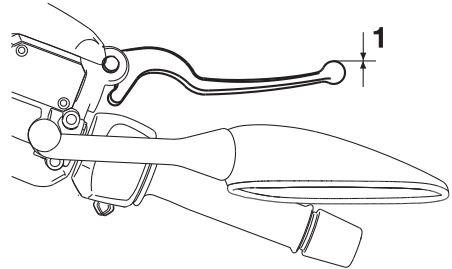

ZAJM1049

1. No brake lever free play

Rear

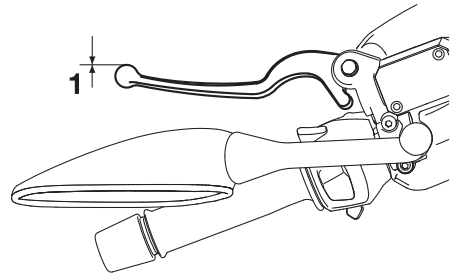

ZAJM1050

1. No brake lever free play

There should be no free play at the brake lever ends. If there is free play, have a Yamaha dealer inspect the brake system.

EWA14212

WARNING

A soft or spongy feeling in the brake lever can indicate the presence of air in the hydraulic system. If there is air in the hydraulic system, have a Yamaha dealer bleed the system before operating the vehicle. Air in the hydraulic system will diminish the

Periodic maintenance and adjustment

braking performance, which may result in loss of control and an accident.

EAU22393

Checking the front and rear brake pads

The front and rear brake pads must be checked for wear at the intervals specified in the periodic maintenance and lubrication chart.

EAU22432

Front brake pads

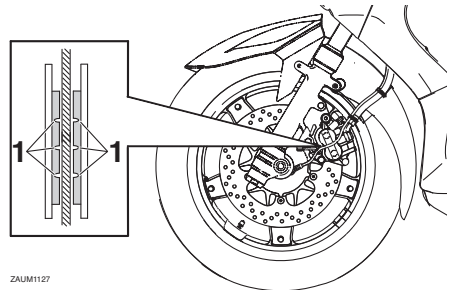

ZAUM1127

1. Wear indicator groove

Each front brake pad is provided with wear indicator grooves, which allow you to check the brake pad wear without having to disassemble the brake. To check the brake pad wear, check the wear indicator grooves. If a brake pad has worn to the point that the wear indicator grooves have almost disappeared, have a Yamaha dealer replace the brake pads as a set.

Periodic maintenance and adjustment

Rear brake pads

EAU22471

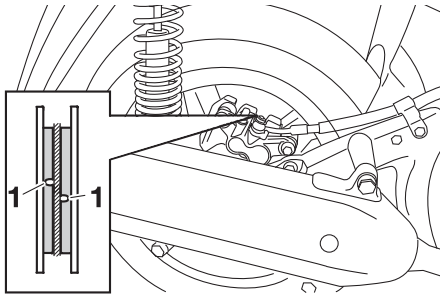

1. Brake pad wear indicator groove

Each rear brake pad is provided with a wear indicator groove, which allows you to check the brake pad wear without having to disassemble the brake. To check the brake pad wear, check the wear indicator groove. If a brake pad has worn to the point that the wear indicator groove has almost disappeared, have a Yamaha dealer replace the brake pads as a set.

Checking the brake fluid level

EAU40262

Before riding, check that the brake fluid is above the minimum level mark. Check the brake fluid level with the top of the reservoir level. Replenish the brake fluid if necessary.

Front brake

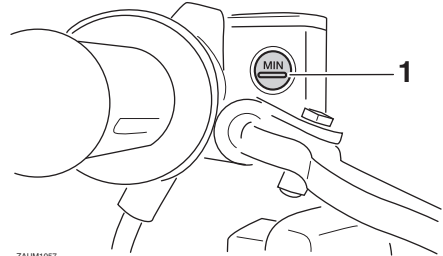

ZAUM1057

1. Minimum level mark

Rear brake

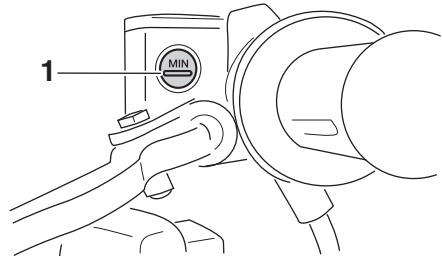

ZAUM1032

1. Minimum level mark

Specified brake fluid:
DOT 4

EWA16011

WARNING

Improper maintenance can result in loss of braking ability. Observe these precautions:

- **Insufficient brake fluid may allow air to enter the brake system, reducing braking performance.**

Periodic maintenance and adjustment

EAU22733

- **Clean the filler cap before removing. Use only DOT 4 brake fluid from a sealed container.**
- **Use only the specified brake fluid; otherwise, the rubber seals may deteriorate, causing leakage.**
- **Refill with the same type of brake fluid. Adding a brake fluid other than DOT 4 may result in a harmful chemical reaction.**
- **Be careful that water or dust does not enter the brake fluid reservoir when refilling. Water will significantly lower the boiling point of the fluid and may result in vapor lock, and dirt may clog the ABS hydraulic unit valves.**

Changing the brake fluid

Have a Yamaha dealer change the brake fluid at the intervals specified in the periodic maintenance and lubrication chart. In addition, have the oil seals of the master cylinders and calipers as well as the brake hoses replaced at the intervals listed below or whenever they are damaged or leaking.

- **Oil seals:** Replace every two years.
- **Brake hoses:** Replace every four years.

ECA17641

NOTICE

Brake fluid may damage painted surfaces or plastic parts. Always clean up spilled fluid immediately.

As the brake pads wear, it is normal for the brake fluid level to gradually go down. A low brake fluid level may indicate worn brake pads and/or brake system leakage; therefore, be sure to check the brake pads for wear and the brake system for leakage. If the brake fluid level goes down suddenly, have a Yamaha dealer check the cause before further riding.

Periodic maintenance and adjustment

EAU23098

Checking and lubricating the cables

The operation of all control cables and the condition of the cables should be checked before each ride, and the cables and cable ends should be lubricated if necessary. If a cable is damaged or does not move smoothly, have a Yamaha dealer check or replace it. **WARNING! Damage to the outer housing of cables may result in internal rusting and cause interference with cable movement. Replace damaged cables as soon as possible to prevent unsafe conditions.** [EWA10712]

EAU23115

Checking and lubricating the throttle grip and cable

The operation of the throttle grip should be checked before each ride. In addition, the cable should be lubricated by a Yamaha dealer at the intervals specified in the periodic maintenance chart.

The throttle cable is equipped with a rubber cover. Make sure that the cover is securely installed. Even though the cover is installed correctly, it does not completely protect the cable from water entry. Therefore, use care not to pour water directly onto the cover or cable when washing the vehicle. If the cable or cover becomes dirty, wipe clean with a moist cloth.

6

Recommended lubricant:

Yamaha cable lubricant or other suitable cable lubricant

Periodic maintenance and adjustment

Lubricating the front and rear brake levers

EAU23173

Front brake lever

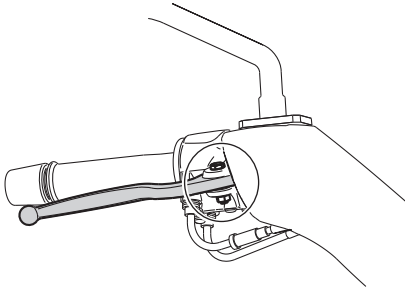

Rear brake lever

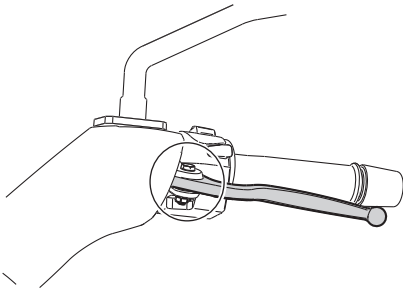

The pivoting points of the front and rear brake levers must be lubricated at the intervals specified in the periodic maintenance and lubrication chart.

Recommended lubricant:

Silicone grease

Checking and lubricating the centerstand and sidestand

EAU23215

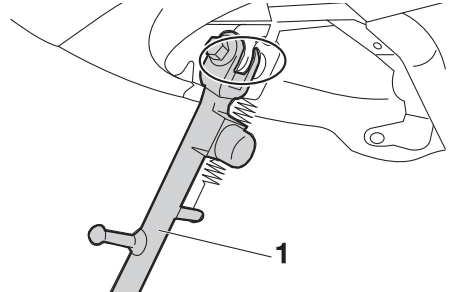

1. Sidestand

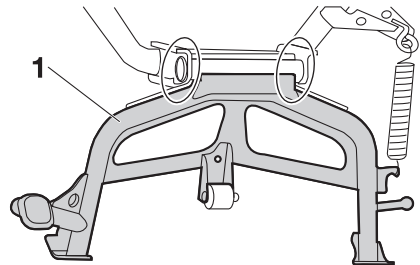

1. Centerstand

The operation of the centerstand and sidestand should be checked before each ride, and the pivots and metal-to-metal contact surfaces should be lubricated if necessary.

EWA10742

⚠ WARNING

If the centerstand or sidestand does not move up and down smoothly, have a Yamaha dealer check or repair it. Otherwise, the centerstand or sidestand could contact the ground and distract the operator, resulting in a possible loss of control.

Recommended lubricant:

Lithium-soap-based grease

Periodic maintenance and adjustment

EAU23273

EAU45512

Checking the front fork

The condition and operation of the front fork must be checked as follows at the intervals specified in the periodic maintenance and lubrication chart.

To check the condition

Check the inner tubes for scratches, damage and excessive oil leakage.

To check the operation

1. Place the vehicle on a level surface and hold it in an upright position. **WARNING! To avoid injury, securely support the vehicle so there is no danger of it falling over.** [EWA10752]
2. While applying the front brake, push down hard on the handlebars several times to check if the front fork compresses and rebounds smoothly.

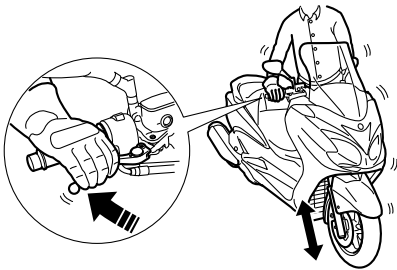

ECA10591

NOTICE

If any damage is found or the front fork does not operate smoothly, have a Yamaha dealer check or repair it.

Checking the steering

Worn or loose steering bearings may cause danger. Therefore, the operation of the steering must be checked as follows at the intervals specified in the periodic maintenance and lubrication chart.

1. Place the vehicle on the center-stand. **WARNING! To avoid injury, securely support the vehicle so there is no danger of it falling over.** [EWA10752]
2. Hold the lower ends of the front fork legs and try to move them forward and backward. If any free play can be felt, have a Yamaha dealer check or repair the steering.

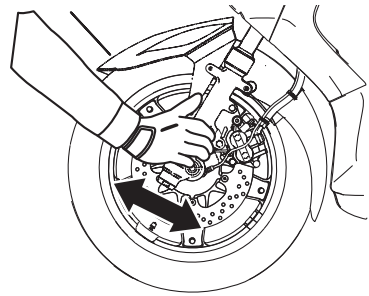

ZAUM1128

Periodic maintenance and adjustment

Checking the wheel bearings

EAU23292



The front and rear wheel bearings must be checked at the intervals specified in the periodic maintenance and lubrication chart. If there is play in the wheel hub or if the wheel does not turn smoothly, have a Yamaha dealer check the wheel bearings.

Battery

EAU46345

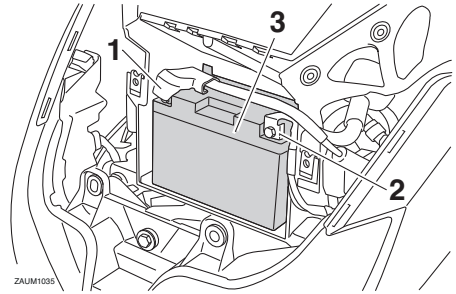

1. Positive battery lead (red)
2. Negative battery lead (black)
3. Battery

The battery is located behind panel C. (See page 6-7.)

This model is equipped with a VRLA (Valve Regulated Lead Acid) battery. There is no need to check the electrolyte or to add distilled water. However, the battery lead connections need to be checked and, if necessary, securely tightened.

6

EWA10761

WARNING

- **Electrolyte is poisonous and dangerous since it contains sulfuric acid, which causes severe burns. Avoid any contact with skin, eyes or clothing and always shield your eyes when working near batteries. In case of contact, administer the following FIRST AID.**
 - **EXTERNAL:** Flush with plenty of water.
 - **INTERNAL:** Drink large quantities of water or milk and immediately call a physician.
 - **EYES:** Flush with water for 15 minutes and seek prompt medical attention.

Periodic maintenance and adjustment

- Batteries produce explosive hydrogen gas. Therefore, keep sparks, flames, cigarettes, etc., away from the battery and provide sufficient ventilation when charging it in an enclosed space.
 - **KEEP THIS AND ALL BATTERIES OUT OF THE REACH OF CHILDREN.**
-

To charge the battery

Have a Yamaha dealer charge the battery as soon as possible if it seems to have discharged. Keep in mind that the battery tends to discharge more quickly if the vehicle is equipped with optional electrical accessories.

ECA16522

NOTICE

To charge a VRLA (Valve Regulated Lead Acid) battery, a special (constant-voltage) battery charger is required. Using a conventional battery charger will damage the battery.

To store the battery

1. If the vehicle will not be used for more than one month, remove the battery, fully charge it, and then place it in a cool, dry place.
NOTICE: When removing the battery, be sure the key is turned to “OFF”, then disconnect the negative lead before disconnecting the positive lead.
[ECA16303]
2. If the battery will be stored for more than two months, check it at least once a month and fully charge it if necessary.

3. Fully charge the battery before installation. **NOTICE: When installing the battery, be sure the key is turned to “OFF”, then connect the positive lead before connecting the negative lead.** [ECA16841]

ECA16531

NOTICE

Always keep the battery charged. Storing a discharged battery can cause permanent battery damage.

Periodic maintenance and adjustment

EAUM3093

Replacing the fuses

The fuse box, which contains the fuses for the individual circuits, is located behind panel B. (See page 6-7.)

TIP

The main fuse, which is in a different and hard-to-reach location, must be replaced by a Yamaha dealer.

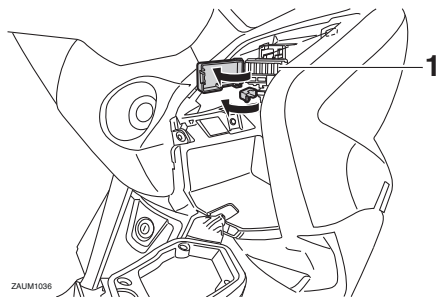

1. Fuse box

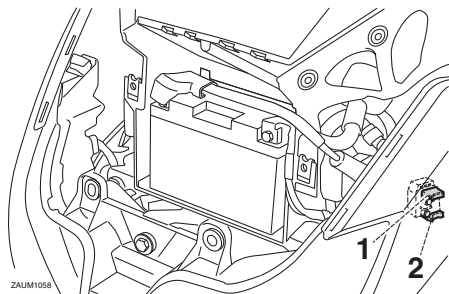

1. Main fuse
2. Spare main fuse

If a fuse for the individual circuits is blown, replace it as follows.

1. Turn the key to "OFF" and turn off the electrical circuit in question.
2. Remove the blown fuse, and then install a new fuse of the specified amperage. **WARNING! Do not use a fuse of a higher amperage rating than recommended to avoid causing extensive damage to the electrical system and possibly a fire.** [EWA15132]

TIP

Fuse tongs are included in the owner's tool kit. Use the tongs to remove and install a fuse.

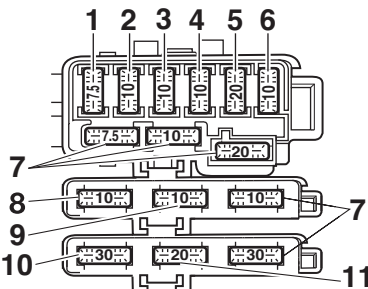

1. Radiator fan motor fuse
2. ECU fuse
3. Backup fuse
4. Signaling system fuse
5. Headlight fuse
6. Ignition fuse
7. Spare fuse
8. Hazard fuse
9. ABS control unit fuse
10. ABS motor fuse
11. ABS solenoid fuse

Periodic maintenance and adjustment

EAU34242

Specified fuses:

- Main fuse:
30.0 A
- Ignition fuse:
10.0 A
- Signaling system fuse:
10.0 A
- Headlight fuse:
20.0 A
- Turn signal light and hazard fuse:
10.0 A
- Radiator fan motor fuse:
7.5 A
- ABS control unit fuse:
10.0 A
- ABS motor fuse:
30.0 A
- ABS solenoid fuse:
20.0 A
- Backup fuse:
10.0 A

Replacing a headlight bulb

This model is equipped with halogen bulb headlights. If a headlight bulb burns out, have a Yamaha dealer replace it and, if necessary, adjust the headlight beam.

6

3. Turn the key to "ON" and turn on the electrical circuit in question to check if the device operates.
4. If the fuse immediately blows again, have a Yamaha dealer check the electrical system.

Periodic maintenance and adjustment

EAUM3860

EAU24182

Auxiliary light bulbs

If an auxiliary light does not come on, have a Yamaha dealer check the electrical circuit or replace the bulb.

Tail/brake light

This model is equipped with an LED-type tail/brake light.

If the tail/brake light does not come on, have a Yamaha dealer check it.

Periodic maintenance and adjustment

Front turn signal light

EAU39881

If a front turn signal light does not come on, have a Yamaha dealer check its electrical circuit or replace the bulb.

Replacing a rear turn signal light bulb

EAUM3062

1. Place the scooter on the center-stand.
2. Open the seat. (See page 3-19.)
3. Remove the rear storage compartment by removing the bolts.
4. Remove the socket (together with the turn signal light bulb) by turning it counterclockwise.

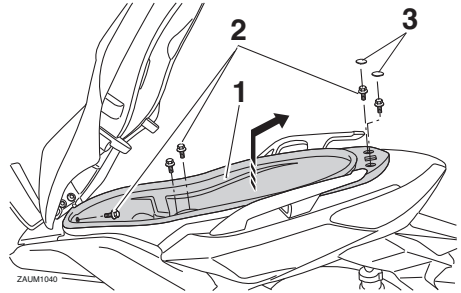

1. Storage compartment
2. Bolt
3. Rubber cap

5. Remove the burnt-out bulb by pushing it in and turning it counterclockwise.

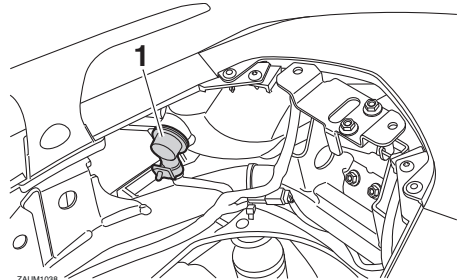

1. Turn signal light bulb socket

6. Insert a new bulb into the socket, push it in, and then turn it clockwise until it stops.

Periodic maintenance and adjustment

EAUM2203

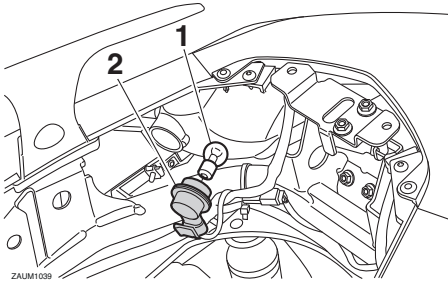

ZALM1029

1. Turn signal light bulb
2. Turn signal light bulb socket
7. Install the socket (together with the bulb) by turning it clockwise.
8. Place the rear storage compartment in the original position and install the bolts.
9. Close the seat.

Replacing the license plate light bulb

1. Remove the socket (together with the bulb) by pulling it out.

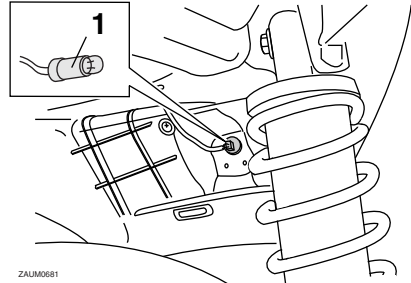

ZALM0681

1. License plate light bulb socket
2. Remove the burnt-out bulb by pulling it out.
3. Insert a new bulb into the socket.
4. Install the socket (together with the bulb) by pushing it in.

Periodic maintenance and adjustment

EAU25882

Troubleshooting

Although Yamaha scooters receive a thorough inspection before shipment from the factory, trouble may occur during operation. Any problem in the fuel, compression, or ignition systems, for example, can cause poor starting and loss of power.

The following troubleshooting charts represent quick and easy procedures for checking these vital systems yourself. However, should your scooter require any repair, take it to a Yamaha dealer, whose skilled technicians have the necessary tools, experience, and know-how to service the scooter properly.

6

Use only genuine Yamaha replacement parts. Imitation parts may look like Yamaha parts, but they are often inferior, have a shorter service life and can lead to expensive repair bills.

EWA15142

WARNING

When checking the fuel system, do not smoke, and make sure there are no open flames or sparks in the area, including pilot lights from water heaters or furnaces. Gasoline or gasoline vapors can ignite or explode, causing severe injury or property damage.

Periodic maintenance and adjustment

EAU68020

Troubleshooting charts

Starting problems or poor engine performance

1. Fuel

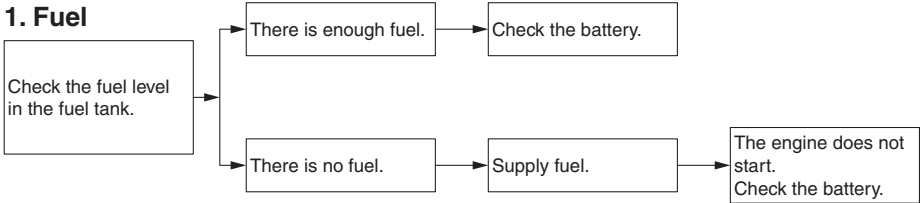

2. Battery

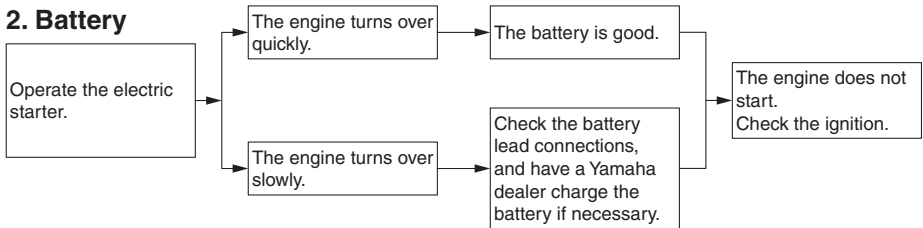

3. Ignition

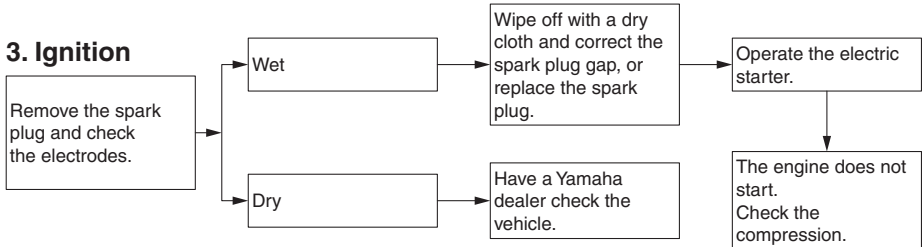

4. Compression

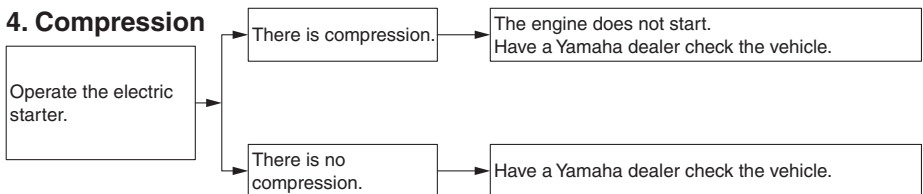

Periodic maintenance and adjustment

Engine overheating

EWAT1041

⚠ WARNING

- Do not remove the radiator cap when the engine and radiator are hot. Scalding hot fluid and steam may be blown out under pressure, which could cause serious injury. Be sure to wait until the engine has cooled.
- Place a thick rag, like a towel, over the radiator cap, and then slowly rotate the cap counterclockwise to the detent to allow any residual pressure to escape. When the hissing sound has stopped, press down on the cap while turning it counterclockwise, and then remove the cap.

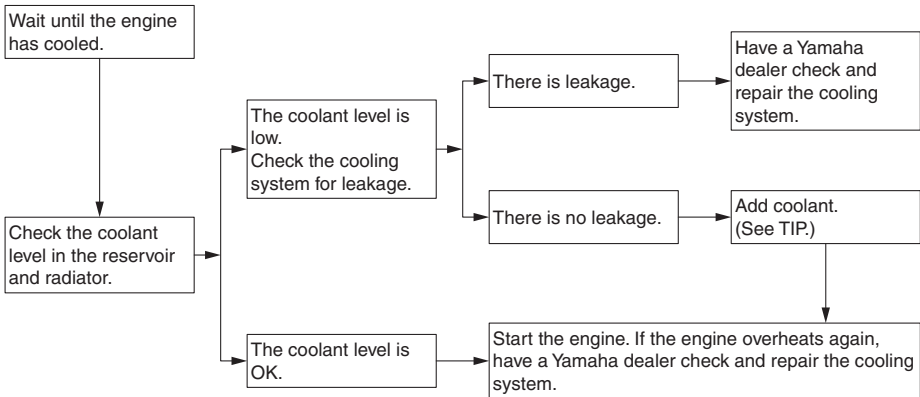

TIP

If coolant is not available, tap water can be temporarily used instead, provided that it is changed to the recommended coolant as soon as possible.

Matte color caution

EAU37834

EAU26096

NOTICE

ECA15193

Some models are equipped with matte colored finished parts. Be sure to consult a Yamaha dealer for advice on what products to use before cleaning the vehicle. Using a brush, harsh chemical products or cleaning compounds when cleaning these parts will scratch or damage their surface. Wax also should not be applied to any matte colored finished parts.

Care

While the open design of a scooter reveals the attractiveness of the technology, it also makes it more vulnerable. Rust and corrosion can develop even if high-quality components are used. A rusty exhaust pipe may go unnoticed on a car, however, it detracts from the overall appearance of a scooter. Frequent and proper care does not only comply with the terms of the warranty, but it will also keep your scooter looking good, extend its life and optimize its performance.

Before cleaning

1. Cover the muffler outlet with a plastic bag after the engine has cooled down.
2. Make sure that all caps and covers as well as all electrical couplers and connectors, including the spark plug cap, are tightly installed.
3. Remove extremely stubborn dirt, like oil burnt onto the crankcase, with a degreasing agent and a brush, but never apply such products onto seals, gaskets and wheel axles. Always rinse the dirt and degreaser off with water.

Cleaning

ECA10784

NOTICE

- Avoid using strong acidic wheel cleaners, especially on spoked wheels. If such products are used on hard-to-remove dirt, do not leave the cleaner on the affected area any longer than in-

Scooter care and storage

structed. Also, thoroughly rinse the area off with water, immediately dry it, and then apply a corrosion protection spray.

- Improper cleaning can damage plastic parts (such as cowlings, panels, windshields, headlight lenses, meter lenses, etc.) and the mufflers. Use only a soft, clean cloth or sponge with water to clean plastic. However, if the plastic parts cannot be thoroughly cleaned with water, diluted mild detergent with water may be used. Be sure to rinse off any detergent residue using plenty of water, as it is harmful to plastic parts.
- Do not use any harsh chemical products on plastic parts. Be sure to avoid using cloths or sponges which have been in contact with strong or abrasive cleaning products, solvent or thinner, fuel (gasoline), rust removers or inhibitors, brake fluid, antifreeze or electrolyte.
- Do not use high-pressure washers or steam-jet cleaners since they cause water seepage and deterioration in the following areas: seals (of wheel and swing-arm bearings, fork and brakes), electric components (couplers, connectors, instruments, switches and lights), breather hoses and vents.
- For scooters equipped with a windshield: Do not use strong cleaners or hard sponges as they will cause dulling or scratching. Some cleaning

compounds for plastic may leave scratches on the windshield. Test the product on a small hidden part of the windshield to make sure that it does not leave any marks. If the windshield is scratched, use a quality plastic polishing compound after washing.

After normal use

Remove dirt with warm water, a mild detergent, and a soft, clean sponge, and then rinse thoroughly with clean water. Use a toothbrush or bottlebrush for hard-to-reach areas. Stubborn dirt and insects will come off more easily if the area is covered with a wet cloth for a few minutes before cleaning.

After riding in the rain, near the sea or on salt-sprayed roads

Since sea salt or salt sprayed on the roads during winter are extremely corrosive in combination with water, carry out the following steps after each ride in the rain, near the sea or on salt-sprayed roads.

TIP

Salt sprayed on roads in the winter may remain well into spring.

1. Clean the scooter with cold water and a mild detergent after the engine has cooled down. **NOTICE: Do not use warm water since it increases the corrosive action of the salt.** [ECA10792]
2. Apply a corrosion protection spray on all metal, including chrome- and nickel-plated, surfaces to prevent corrosion.

Cleaning the windshield

Avoid using any alkaline or strong acid cleaner, gasoline, brake fluid, or any other solvent. Clean the windshield with a cloth or sponge dampened with a mild detergent, and then wash it off thoroughly with water. For additional cleaning, use Yamaha Windshield Cleaner or another high-quality windshield cleaner. Some cleaning compounds for plastics may leave scratches on the windshield. Before using such cleaners, test an area of the windshield which does not affect your visibility and which cannot be easily recognized.

After cleaning

1. Dry the scooter with a chamois or an absorbing cloth.
2. Use a chrome polish to shine chrome, aluminum and stainless-steel parts, including the exhaust system. (Even the thermally induced discoloring of stainless-steel exhaust systems can be removed through polishing.)
3. To prevent corrosion, it is recommended to apply a corrosion protection spray on all metal, including chrome- and nickel-plated, surfaces.
4. Use spray oil as a universal cleaner to remove any remaining dirt.
5. Touch up minor paint damage caused by stones, etc.
6. Wax all painted surfaces.
7. Let the scooter dry completely before storing or covering it.

WARNING

Contaminants on the brakes or tires can cause loss of control.

- **Make sure that there is no oil or wax on the brakes or tires. If necessary, clean the brake discs and brake linings with a regular brake disc cleaner or acetone, and wash the tires with warm water and a mild detergent.**
- **Before operating the scooter test its braking performance and cornering behavior.**

ECA10801

NOTICE

- **Apply spray oil and wax sparingly and make sure to wipe off any excess.**
- **Never apply oil or wax to any rubber and plastic parts, but treat them with a suitable care product.**
- **Avoid using abrasive polishing compounds as they will wear away the paint.**

TIP

- Consult a Yamaha dealer for advice on what products to use.
- Washing, rainy weather or humid climates can cause the headlight lens to fog. Turning the headlight on for a short period of time will help remove the moisture from the lens.

Scooter care and storage

EAU36564

Storage

Short-term

Always store your scooter in a cool, dry place and, if necessary, protect it against dust with a porous cover. Be sure the engine and the exhaust system are cool before covering the scooter.

ECA10821

NOTICE

- **Storing the scooter in a poorly ventilated room or covering it with a tarp, while it is still wet, will allow water and humidity to seep in and cause rust.**
- **To prevent corrosion, avoid damp cellars, stables (because of the presence of ammonia) and areas where strong chemicals are stored.**

Long-term

Before storing your scooter for several months:

1. Follow all the instructions in the “Care” section of this chapter.
2. Fill up the fuel tank and add fuel stabilizer (if available) to prevent the fuel tank from rusting and the fuel from deteriorating.
3. Perform the following steps to protect the cylinder, piston rings, etc. from corrosion.
 - a. Remove the spark plug cap and spark plug.
 - b. Pour a teaspoonful of engine oil into the spark plug bore.
 - c. Install the spark plug cap onto the spark plug, and then place the spark plug on the cylinder

head so that the electrodes are grounded. (This will limit sparking during the next step.)

- d. Turn the engine over several times with the starter. (This will coat the cylinder wall with oil.)
 - e. Remove the spark plug cap from the spark plug, and then install the spark plug and the spark plug cap. **WARNING! To prevent damage or injury from sparking, make sure to ground the spark plug electrodes while turning the engine over.** [EWA10952]
4. Lubricate all control cables and the pivoting points of all levers and pedals as well as of the side-stand/centerstand.
 5. Check and, if necessary, correct the tire air pressure, and then lift the scooter so that both of its wheels are off the ground. Alternatively, turn the wheels a little every month in order to prevent the tires from becoming degraded in one spot.
 6. Cover the muffler outlet with a plastic bag to prevent moisture from entering it.
 7. Remove the battery and fully charge it. Store it in a cool, dry place and charge it once a month. Do not store the battery in an excessively cold or warm place [less than 0 °C (30 °F) or more than 30 °C (90 °F)]. For more information on storing the battery, see page 6-27.

Scooter care and storage

TIP _____

Make any necessary repairs before storing the scooter.

Specifications

Dimensions:

- Overall length:
2160 mm (85.0 in)
- Overall width:
790 mm (31.1 in)
- Overall height:
1385 mm (54.5 in)
- Seat height:
785 mm (30.9 in)
- Wheelbase:
1525 mm (60.0 in)
- Ground clearance:
125 mm (4.92 in)
- Minimum turning radius:
2500 mm (98.4 in)

Weight:

- Curb weight:
173 kg (381 lb)

Engine:

- Engine type:
Liquid cooled 4-stroke, SOHC
- Cylinder arrangement:
Single cylinder
- Displacement:
124 cm³
- Bore × stroke:
52.0 × 58.6 mm (2.05 × 2.31 in)
- Compression ratio:
11.2 : 1
- Starting system:
Electric starter
- Lubrication system:
Wet sump

Engine oil:

- Recommended brand:
YAMALUBE
- Type:
SAE 10W-30, 10W-40, 15W-40, 20W-40 or 20W-50

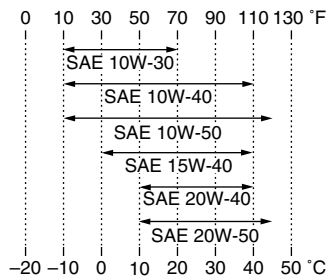

- Recommended engine oil grade:
API service SG type or higher, JASO standard MA

Engine oil quantity:

- Without oil filter element replacement:
1.40 L (1.48 US qt, 1.23 Imp.qt)
- With oil filter element replacement:
1.50 L (1.59 US qt, 1.32 Imp.qt)

Final transmission oil:

- Type:
YAMALUBE 10W-40 or SAE 10W-30 type SE motor oil
- Quantity:
0.21 L (0.22 US qt, 0.18 Imp.qt)

Coolant quantity:

- Coolant reservoir (up to the maximum level mark):
0.32 L (0.34 US qt, 0.28 Imp.qt)
- Radiator (including all routes):
1.10 L (1.16 US qt, 0.97 Imp.qt)

Air filter:

- Air filter element:
Oil-coated paper element

Fuel:

- Recommended fuel:
Premium unleaded gasoline (Gasohol (E10) acceptable)
- Fuel tank capacity:
13.2 L (3.48 US gal, 2.90 Imp.gal)
- Fuel reserve amount:
2.5 L (0.66 US gal, 0.55 Imp.gal)

Fuel injection:

- Throttle body:
ID mark:
2DS1 00

Spark plug(s):

- Manufacturer/model:
NGK/CR9E

Spark plug gap:
0.7–0.8 mm (0.028–0.031 in)

Clutch:

Clutch type:
Dry, centrifugal automatic

Transmission:

Primary reduction ratio:
(1.000)
Final drive:
Gear
Secondary reduction ratio:
41/14 × 44/13 (9.912)
Transmission type:
V-belt automatic
Operation:
Centrifugal automatic type

Chassis:

Frame type:
Underbone
Caster angle:
28.0 °
Trail:
100 mm (3.9 in)

Front tire:

Type:
Tubeless
Size:
120/70-15 M/C 56S(MICHELIN)
Manufacturer/model:
MICHELIN / CITYGRIP

Rear tire:

Type:
Tubeless
Size:
140/70-14 M/C 68S(MICHELIN)
Manufacturer/model:
MICHELIN / CITYGRIP

Loading:

Maximum load:
181 kg (399 lb)
(Total weight of rider, passenger, cargo
and accessories)

Tire air pressure (measured on cold tires):

Loading condition:
0–90 kg (0–198 lb)
Front:
190 kPa (1.90 kgf/cm², 28 psi)
Rear:
220 kPa (2.20 kgf/cm², 32 psi)

Loading condition:
90–181 kg (198–399 lb)

Loading condition:
90 kg - maximum load
Front:
210 kPa (2.10 kgf/cm², 30 psi)
Rear:
250 kPa (2.50 kgf/cm², 36 psi)

Front wheel:

Wheel type:
Cast wheel
Rim size:
15 x MT3.5

Rear wheel:

Wheel type:
Cast wheel
Rim size:
14 x MT3.75

Front brake:

Type:
Single disc brake
Operation:
Right hand operation
Specified brake fluid:
DOT 4

Rear brake:

Type:
Single disc brake
Operation:
Left hand operation
Specified brake fluid:
DOT 4

Front suspension:

Type:
Telescopic fork
Spring/shock absorber type:
Coil spring/oil damper
Wheel travel:
110 mm (4.3 in)

Rear suspension:

Type:
Unit swing
Spring/shock absorber type:
Coil spring/oil damper
Wheel travel:
84 mm (3.3 in)

Electrical system:

System voltage:
12 V

Specifications

Ignition system:

TCI

Charging system:

AC magneto

Battery:

Model:

GT9B-4

Voltage, capacity:

12 V, 8.0 Ah

Headlight:

Bulb type:

Halogen bulb

Bulb voltage, wattage × quantity:

Headlight:

12 V, 55.0 W × 2

Brake/tail light:

LED

Front turn signal light:

12 V, 10.0 W × 2

Rear turn signal light:

12 V, 10.0 W × 2

Auxiliary light:

12 V, 5.0 W × 2

License plate light:

12 V, 5.0 W × 1

Meter lighting:

LED

High beam indicator light:

LED

Turn signal indicator light:

LED

Fuel level warning light:

LED

Engine trouble warning light:

LED

ABS warning light:

LED

Fuse:

Main fuse:

30.0 A

Headlight fuse:

20.0 A

Signaling system fuse:

10.0 A

Ignition fuse:

10.0 A

Radiator fan motor fuse:

7.5 A

Turn signal light and hazard fuse:

10.0 A

ECU fuse:

10.0 A

ABS control unit fuse:

10.0 A

ABS motor fuse:

30.0 A

ABS solenoid fuse:

20.0 A

Backup fuse:

10.0 A

EAU53562

Identification numbers

Record the vehicle identification number, engine serial number, and the model label information in the spaces provided below. These identification numbers are needed when registering the vehicle with the authorities in your area and when ordering spare parts from a Yamaha dealer.

VEHICLE IDENTIFICATION NUMBER:

ENGINE SERIAL NUMBER:

MODEL LABEL INFORMATION:

Vehicle identification number

EAU26411

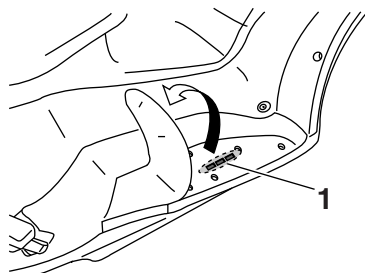

1. Vehicle identification number

The vehicle identification number is stamped into the frame.

TIP

The vehicle identification number is used to identify your vehicle and may be used to register it with the licensing authority in your area.

EAU26442

Engine serial number

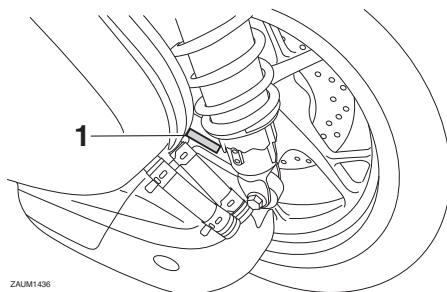

ZAJM1436

1. Engine serial number

The engine serial number is stamped into the crankcase.

EAU26461

Model label

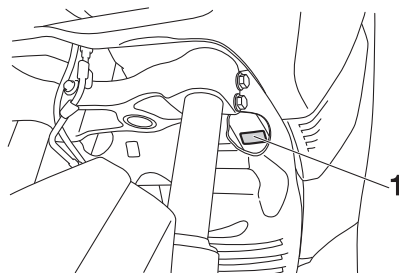

1. Model label

The model label is affixed to the location shown. Record the information on this label in the space provided. This information will be needed when ordering spare parts from a Yamaha dealer.

Diagnostic connectors

EAUM3880

EAU74701

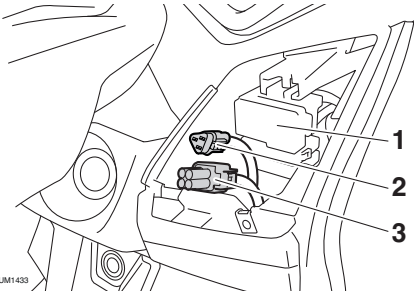

1. Fuse box
2. FI diagnostic connector
3. ABS diagnostic connector

The ABS and Fuel Injection diagnostic connectors are located as shown.

Vehicle data recording

This model's ECU stores certain vehicle data to assist in the diagnosis of malfunctions and for research and development purposes. This data will be uploaded only when a special Yamaha diagnostic tool is attached to the vehicle, such as when maintenance checks or service procedures are performed.

Although the sensors and recorded data will vary by model, the main data points are:

- Vehicle status and engine performance data
- Fuel-injection and emission-related data

Yamaha will not disclose this data to a third party except:

- With the consent of the vehicle owner
- Where obligated by law
- For use by Yamaha in litigation
- For general Yamaha-conducted research purposes when the data is not related to an individual vehicle nor owner

- A**
- ABS 3-15
 - ABS warning light..... 3-4
 - Acceleration and deceleration..... 5-3
 - Air filter and V-belt case air filter
 - elements 6-15
 - Auxiliary light bulbs 6-31
- B**
- Battery 6-27
 - Brake fluid, changing 6-23
 - Brake fluid level, checking 6-22
 - Brake lever, front 3-14
 - Brake lever, rear 3-15
 - Brake levers, lubricating..... 6-25
 - Braking 5-4
- C**
- Cables, checking and lubricating 6-24
 - Care..... 7-1
 - Catalytic converters 3-18
 - Centerstand and sidestand, checking
 - and lubricating 6-25
 - Coolant..... 6-14
- D**
- Data recording, vehicle 9-2
 - Diagnostic connectors 9-2
 - Dimmer switch 3-13
- E**
- Engine break-in 5-5
 - Engine oil..... 6-10
 - Engine serial number..... 9-1
 - Engine trouble warning light..... 3-4
- F**
- Final transmission oil..... 6-13
 - Front and rear brake lever free play,
 - checking..... 6-20
 - Front and rear brake pads, checking ... 6-21
 - Front fork, checking 6-26
 - Front turn signal light 6-32
 - Fuel..... 3-17
 - Fuel consumption, tips for reducing 5-5
 - Fuel level warning light..... 3-4
 - Fuel tank cap..... 3-16
 - Fuses, replacing 6-29
- H**
- Handlebar switches..... 3-13
 - Hazard switch 3-13
 - Headlight bulb, replacing 6-30
 - High beam indicator light 3-4
 - Horn switch 3-13
- I**
- Identification numbers 9-1
 - Ignition circuit cut-off system 3-23
 - Immobilizer system 3-1
 - Immobilizer system indicator light 3-5
 - Indicator lights and warning lights 3-4
 - Info switch 3-14
- L**
- License plate light bulb, replacing 6-33
- M**
- Main switch/steering lock 3-2
 - Maintenance and lubrication, periodic ... 6-4
 - Maintenance, emission control
 - system 6-3
 - Matte color, caution..... 7-1
 - Model label 9-1
 - Multi-function meter unit 3-6
- P**
- Panels, removing and installing 6-7
 - Parking..... 5-6
 - Part locations..... 2-1
 - Pass switch..... 3-13
- S**
- Safe-riding points 1-5
 - Safety information..... 1-1
 - Seat..... 3-19
 - Shock absorber assemblies,
 - adjusting 3-21
 - Sidestand..... 3-22
 - Spark plug, checking 6-9
 - Specifications 8-1
 - Starting off 5-3
 - Starting the engine..... 5-2
 - Start switch..... 3-13
 - Steering, checking 6-26
 - Storage 7-4
 - Storage compartments 3-20
- T**
- Tail/brake light 6-31
 - Throttle grip and cable, checking and
 - lubricating 6-24
 - Throttle grip free play, checking 6-17
 - Tires 6-18
 - Tool kit 6-2
 - Troubleshooting..... 6-34
 - Troubleshooting charts 6-35
 - Turn signal indicator lights..... 3-4
 - Turn signal light bulb (rear), replacing... 6-32
 - Turn signal switch 3-13

Index

V

- Valve clearance.....6-17
- Vehicle identification number9-1

W

- Wheel bearings, checking.....6-27
- Wheels6-20



MBK Industrie

Z.I. de Rouvroy 02100 Saint Quentin

SAS au capital de 14 000 000 €

R.C St-Quentin B 329 035 422