



 Read this manual carefully before operating this vehicle.

OWNER'S MANUAL

max
125i

YP125R

1B9-F8199-E3

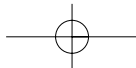

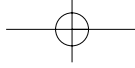

 **Read this manual carefully before operating this vehicle. This manual should stay with this vehicle if it is sold.**



YAMAHA MOTOR ELECTRONICS CO., LTD.
1450-6, Mori, Mori-machi, Shuchi-gun, Shizuoka-ken, 437-0292 Japan

DECLARATION of CONFORMITY

We

Company: YAMAHA MOTOR ELECTRONICS CO., LTD.

Address: 1450-6, Mori, Mori-Machi, Shuchi-gun, Shizuoka-Ken, 437-0292 Japan

Hereby declare that the product:

Kind of equipment: IMMOBILIZER

Type-designation: SSL-00

is in compliance with following norm(s) or documents:

R&TTE Directive(1999/5/EC)

EN300 330-2 v1.1.1(2001-6), EN60950-1(2001)

Two or Three-Wheel Motor Vehicles Directive(97/24/EC: Chapter 8, EMC)

Place of issue: Shizuoka, Japan

Date of issue: 1 Aug. 2002

Revision record

No.	Contents	Date
1	To change contact person and integrate type-designation.	9 Jun. 2005
2	Version up the norm of EN60950 to EN60950-1	27 Feb. 2006
3	To change company name	1 Mar. 2007

General manager of quality assurance div.

01/Mar/2007
T. Rojaki

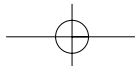

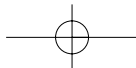

INTRODUCTION

EAU10113

Welcome to the Yamaha world of motorcycling!

As the owner of the YP125R, you are benefiting from Yamaha's vast experience and newest technology regarding the design and manufacture of high-quality products, which have earned Yamaha a reputation for dependability.

Please take the time to read this manual thoroughly, so as to enjoy all advantages of your YP125R. The Owner's Manual does not only instruct you in how to operate, inspect and maintain your scooter, but also in how to safeguard yourself and others from trouble and injury.

In addition, the many tips given in this manual will help keep your scooter in the best possible condition. If you have any further questions, do not hesitate to contact your Yamaha dealer.

The Yamaha team wishes you many safe and pleasant rides. So, remember to put safety first!

Yamaha continually seeks advancements in product design and quality. Therefore, while this manual contains the most current product information available at the time of printing, there may be minor discrepancies between your scooter and this manual. If there is any question concerning this manual, please consult a Yamaha dealer.

EWA12411

WARNING

Please read this manual carefully and completely before operating this scooter.

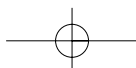

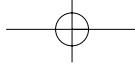

IMPORTANT MANUAL INFORMATION

EAU10132

Particularly important information is distinguished in this manual by the following notations:

	This is the safety alert symbol. It is used to alert you to potential personal injury hazards. Obey all safety messages that follow this symbol to avoid possible injury or death.
	A WARNING indicates a hazardous situation which, if not avoided, could result in death or serious injury.
	A NOTICE indicates special precautions that must be taken to avoid damage to the vehicle or other property.
TIP	A TIP provides key information to make procedures easier or clearer.

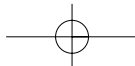

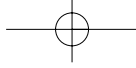

IMPORTANT MANUAL INFORMATION

EAUS1172

**YP125R
OWNER'S MANUAL
©2008 by YAMAHA MOTOR ESPAÑA S.A.
1st edition, October 2008
All rights reserved.
Any reprinting or unauthorized use
without the written permission of
YAMAHA MOTOR ESPAÑA S.A.
is expressly prohibited.
Printed in Spain.**

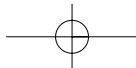

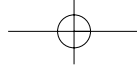
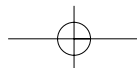

TABLE OF CONTENTS

SAFETY INFORMATION	1-1	Fuel tank cap	3-11	Periodic maintenance chart for the emission control system	6-2
Further safe-riding points	1-5	Fuel	3-12	General maintenance and lubrication chart	6-3
DESCRIPTION	2-1	Catalytic converters.....	3-13	Removing and installing the cowlings and panel	6-6
Left view	2-1	Securing bracket	3-14	Checking the spark plug	6-8
Right view	2-2	Seat.....	3-14	Engine oil	6-9
Controls and instruments	2-3	Storage compartments.....	3-15	Final transmission oil.....	6-12
INSTRUMENT AND CONTROL		Front storage compartment.....	3-16	Coolant	6-13
FUNCTIONS	3-1	Rear storage compartment.....	3-17	Air filter and V-belt case air filter elements.....	6-14
Immobilizer system.....	3-1	Adjusting the shock absorber assemblies.....	3-18	Adjusting the throttle cable free play.....	6-15
Main switch/steering lock.....	3-2	Sidestand.....	3-18	Valve clearance.....	6-16
Indicator and warning lights	3-3	Ignition circuit cut-off system	3-19	Tires	6-16
Turn signal indicator lights	3-3	FOR YOUR SAFETY – PRE- OPERATION CHECKS	4-1	Cast wheels	6-18
High beam indicator light	3-3	OPERATION AND IMPORTANT RIDING POINTS	5-1	Front and rear brake lever free play.....	6-19
Fuel level warning light	3-4	Starting the engine	5-1	Checking the front and rear brake pads.....	6-19
Engine trouble warning light	3-4	Starting off	5-2	Checking the brake fluid level	6-20
Immobilizer system indicator light	3-4	Acceleration and deceleration	5-3	Changing the brake fluid	6-21
Speedometer	3-5	Braking.....	5-3	Checking and lubricating the cables.....	6-21
Fuel gauge	3-5	Tips for reducing fuel consumption..	5-4	Checking and lubricating the throttle grip and cable	6-22
Coolant temperature gauge.....	3-5	Engine break-in.....	5-4	Lubricating the front and rear brake levers.....	6-22
Multi-function display	3-6	Parking.....	5-5	Checking and lubricating the centerstand and sidestand	6-22
Anti-theft alarm (optional)	3-9	PERIODIC MAINTENANCE AND ADJUSTMENT	6-1		
Handlebar switches	3-9	Owner’s tool kit.....	6-1		
Dimmer switch	3-9	Periodic maintenance and lubrication chart	6-2		
Turn signal switch	3-9				
Horn switch	3-9				
Start switch	3-9				
Hazard switch	3-10				
Front brake lever.....	3-10				
Rear brake lever.....	3-10				



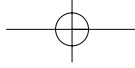
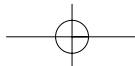
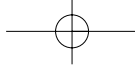

TABLE OF CONTENTS

Checking the front fork.....	6-23
Checking the steering.....	6-24
Checking the wheel bearings	6-24
Battery	6-24
Replacing the fuses	6-26
Replacing a headlight bulb.....	6-28
Replacing a front turn signal light bulb	6-29
Replacing a tail/brake light bulb or a rear turn signal light bulb.....	6-29
Replacing the license plate light bulb	6-31
Replacing an auxiliary light bulb.....	6-31
Troubleshooting	6-32
Troubleshooting charts	6-33
SCOOTER CARE AND STORAGE	7-1
Matte color caution.....	7-1
Care	7-1
Storage	7-3
SPECIFICATIONS	8-1
CONSUMER INFORMATION	9-1
Identification numbers	9-1
Key identification number.....	9-1
Vehicle identification number.....	9-1
Model label	9-2





SAFETY INFORMATION

EAU10263

Be a Responsible Owner

As the vehicle's owner, you are responsible for the safe and proper operation of your scooter.

Scooters are single-track vehicles. Their safe use and operation are dependent upon the use of proper riding techniques as well as the expertise of the operator. Every operator should know the following requirements before riding this scooter.

He or she should:

- Obtain thorough instructions from a competent source on all aspects of scooter operation.
- Observe the warnings and maintenance requirements in this Owner's Manual.
- Obtain qualified training in safe and proper riding techniques.
- Obtain professional technical service as indicated in this Owner's Manual and/or when made necessary by mechanical conditions.

Safe Riding

Perform the pre-operation checks each time you use the vehicle to make sure it is in safe operating condition. Failure to inspect or maintain the vehicle properly increases the possibility of an accident or equipment damage. See page 4-1 for a list of pre-operation checks.

- This scooter is designed to carry the operator and a passenger.
- The failure of motorists to detect and recognize scooters in traffic is the predominating cause of automobile/scooter accidents. Many accidents have been caused by an automobile driver who did not see the scooter. Making yourself conspicuous appears to be very effective in reducing the chance of this type of accident.

Therefore:

- Wear a brightly colored jacket.
- Use extra caution when you are approaching and passing through intersections, since intersections are the most likely places for scooter acci-

dents to occur.

- Ride where other motorists can see you. Avoid riding in another motorist's blind spot.
- Many accidents involve inexperienced operators. In fact, many operators who have been involved in accidents do not even have a current driver's license.
- Make sure that you are qualified and that you only lend your scooter to other qualified operators.
- Know your skills and limits. Staying within your limits may help you to avoid an accident.
- We recommend that you practice riding your scooter where there is no traffic until you have become thoroughly familiar with the scooter and all of its controls.
- Many accidents have been caused by error of the scooter operator. A typical error made by the operator is veering wide on a turn due to excessive speed or undercornering (insufficient lean angle for the speed).

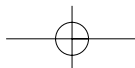

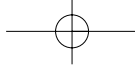

SAFETY INFORMATION

- Always obey the speed limit and never travel faster than warranted by road and traffic conditions.
- Always signal before turning or changing lanes. Make sure that other motorists can see you.
- The posture of the operator and passenger is important for proper control.
 - The operator should keep both hands on the handlebar and both feet on the operator footrests during operation to maintain control of the scooter.
 - The passenger should always hold onto the operator, the seat strap or grab bar, if equipped, with both hands and keep both feet on the passenger footrests. Never carry a passenger unless he or she can firmly place both feet on the passenger footrests.
- Never ride under the influence of alcohol or other drugs.

- This scooter is designed for on-road use only. It is not suitable for off-road use.

Protective apparel

The majority of fatalities from scooter accidents are the result of head injuries. The use of a safety helmet is the single most critical factor in the prevention or reduction of head injuries.

- Always wear an approved helmet.
- Wear a face shield or goggles. Wind in your unprotected eyes could contribute to an impairment of vision that could delay seeing a hazard.
- The use of a jacket, substantial shoes, trousers, gloves, etc., is effective in preventing or reducing abrasions or lacerations.
- Never wear loose-fitting clothes, otherwise they could catch on the control levers or wheels and cause injury or an accident.
- Always wear protective clothing that covers your legs, ankles, and feet. The engine or exhaust system become very hot during or

after operation and can cause burns.

- A passenger should also observe the above precautions.

Avoid Carbon Monoxide Poisoning

All engine exhaust contains carbon monoxide, a deadly gas. Breathing carbon monoxide can cause headaches, dizziness, drowsiness, nausea, confusion, and eventually death.

Carbon Monoxide is a colorless, odorless, tasteless gas which may be present even if you do not see or smell any engine exhaust. Deadly levels of carbon monoxide can collect rapidly and you can quickly be overcome and unable to save yourself. Also, deadly levels of carbon monoxide can linger for hours or days in enclosed or poorly ventilated areas. If you experience any symptoms of carbon monoxide poisoning, leave the area immediately, get fresh air, and **SEEK MEDICAL TREATMENT.**

- Do not run engine indoors. Even if you try to ventilate engine exhaust with fans or open win-

1-2

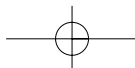

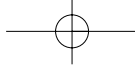

SAFETY INFORMATION

dows and doors, carbon monoxide can rapidly reach dangerous levels.

- Do not run engine in poorly ventilated or partially enclosed areas such as barns, garages, or carports.
- Do not run engine outdoors where engine exhaust can be drawn into a building through openings such as windows and doors.

1 Loading

Adding accessories or cargo to your scooter can adversely affect stability and handling if the weight distribution of the scooter is changed. To avoid the possibility of an accident, use extreme caution when adding cargo or accessories to your scooter. Use extra care when riding a scooter that has added cargo or accessories. Here, along with the information about accessories below, are some general guidelines to follow if loading cargo to your scooter:

The total weight of the operator, passenger, accessories and cargo must not exceed the maximum load limit.

Operation of an overloaded vehicle could cause an accident.

<p>Maximum load: 189 kg (417 lb)</p>

When loading within this weight limit, keep the following in mind:

- Cargo and accessory weight should be kept as low and close to the scooter as possible. Securely pack your heaviest items as close to the center of the vehicle as possible and make sure to distribute the weight as evenly as possible on both sides of the scooter to minimize imbalance or instability.
- Shifting weights can create a sudden imbalance. Make sure that accessories and cargo are securely attached to the scooter before riding. Check accessory mounts and cargo restraints frequently.
- Properly adjust the suspension for your load (suspension-adjustable models only), and check the condition and pressure of your tires.

- Never attach any large or heavy items to the handlebar, front fork, or front fender. Such items can create unstable handling or a slow steering response.

- **This vehicle is not designed to pull a trailer or to be attached to a sidecar.**

Genuine Yamaha Accessories

Choosing accessories for your vehicle is an important decision. Genuine Yamaha accessories, which are available only from a Yamaha dealer, have been designed, tested, and approved by Yamaha for use on your vehicle.

Many companies with no connection to Yamaha manufacture parts and accessories or offer other modifications for Yamaha vehicles. Yamaha is not in a position to test the products that these aftermarket companies produce. Therefore, Yamaha can neither endorse nor recommend the use of accessories not sold by Yamaha or modifications not specifically recommended by Yamaha, even if sold and installed by a Yamaha dealer.

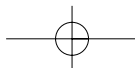

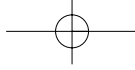

SAFETY INFORMATION

Aftermarket Parts, Accessories, and Modifications

While you may find aftermarket products similar in design and quality to genuine Yamaha accessories, recognize that some aftermarket accessories or modifications are not suitable because of potential safety hazards to you or others. Installing aftermarket products or having other modifications performed to your vehicle that change any of the vehicle's design or operation characteristics can put you and others at greater risk of serious injury or death. You are responsible for injuries related to changes in the vehicle.

Keep the following guidelines in mind, as well as those provided under "Loading" when mounting accessories.

- Never install accessories or carry cargo that would impair the performance of your scooter. Carefully inspect the accessory before using it to make sure that it does not in any way reduce ground clearance or cornering clearance, limit suspension travel, steering travel or control operation,

or obscure lights or reflectors.

- Accessories fitted to the handlebar or the front fork area can create instability due to improper weight distribution or aerodynamic changes. If accessories are added to the handlebar or front fork area, they must be as lightweight as possible and should be kept to a minimum.
- Bulky or large accessories may seriously affect the stability of the scooter due to aerodynamic effects. Wind may attempt to lift the scooter, or the scooter may become unstable in cross winds. These accessories may also cause instability when passing or being passed by large vehicles.
- Certain accessories can displace the operator from his or her normal riding position. This improper position limits the freedom of movement of the operator and may limit control ability, therefore, such

accessories are not recommended.

- Use caution when adding electrical accessories. If electrical accessories exceed the capacity of the scooter's electrical system, an electric failure could result, which could cause a dangerous loss of lights or engine power.

Aftermarket Tires and Rims

The tires and rims that came with your scooter were designed to match the performance capabilities and to provide the best combination of handling, braking, and comfort. Other tires, rims, sizes, and combinations may not be appropriate. Refer to page 6-16 for tire specifications and more information on replacing your tires.



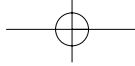

SAFETY INFORMATION

EAU10372

Further safe-riding points

1

- Be sure to signal clearly when making turns.
- Braking can be extremely difficult on a wet road. Avoid hard braking, because the scooter could slide. Apply the brakes slowly when stopping on a wet surface.
- Slow down as you approach a corner or turn. Once you have completed a turn, accelerate slowly.
- Be careful when passing parked cars. A driver might not see you and open a door in your path.
- Railroad crossings, streetcar rails, iron plates on road construction sites, and manhole covers become extremely slippery when wet. Slow down and cross them with caution. Keep the scooter upright, otherwise it could slide out from under you.
- The brake pads could get wet when you wash the scooter. After washing the scooter, check the brakes before riding.
- Always wear a helmet, gloves, trousers (tapered around the cuff and ankle so they do not flap), and a bright colored jacket.
- Do not carry too much luggage on the scooter. An overloaded scooter is unstable. Use a strong cord to secure any luggage to the carrier (if equipped). A loose load will affect the stability of the scooter and could divert your attention from the road. (See page 1-1).

1-5

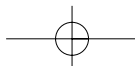

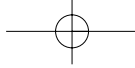

DESCRIPTION

EAU10410

Left view

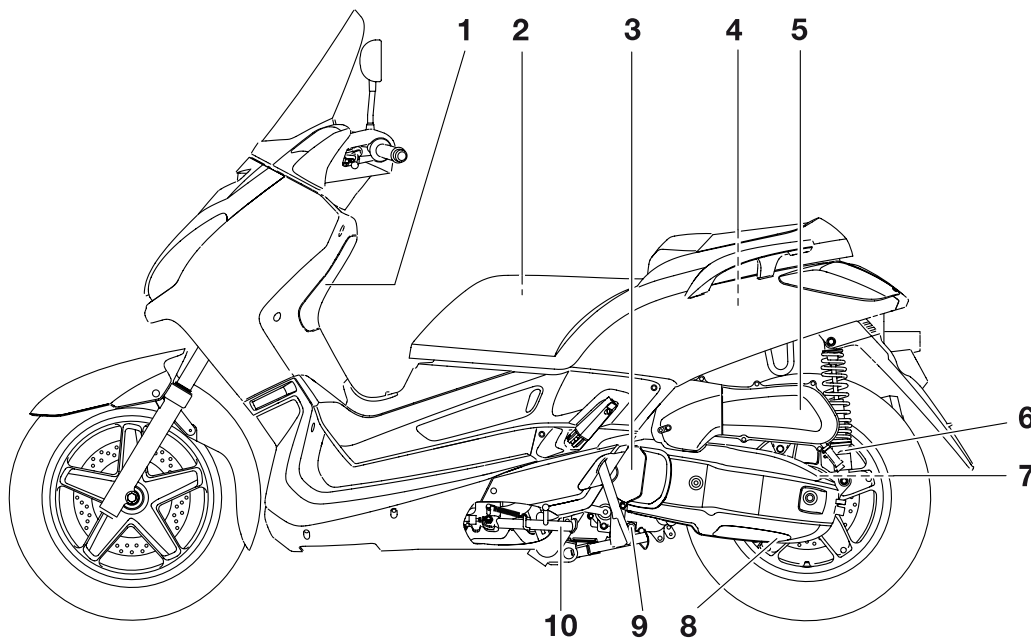

1. Battery (page 6-24)
2. Owner's tool kit (page 6-1)
3. V-belt case air filter element (page 6-14)
4. Rear storage compartment (page 3-17)
5. Air filter element (page 6-14)
6. Shock absorber assembly spring preload adjusting ring (page 3-18)
7. Final transmission oil filler cap (page 6-12)
8. Final transmission oil drain bolt (page 6-12)

9. Engine oil drain bolt (page 6-9)
10. Sidestand (page 6-22)

2-1

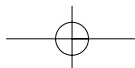

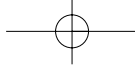

DESCRIPTION

EAU10420

Right view

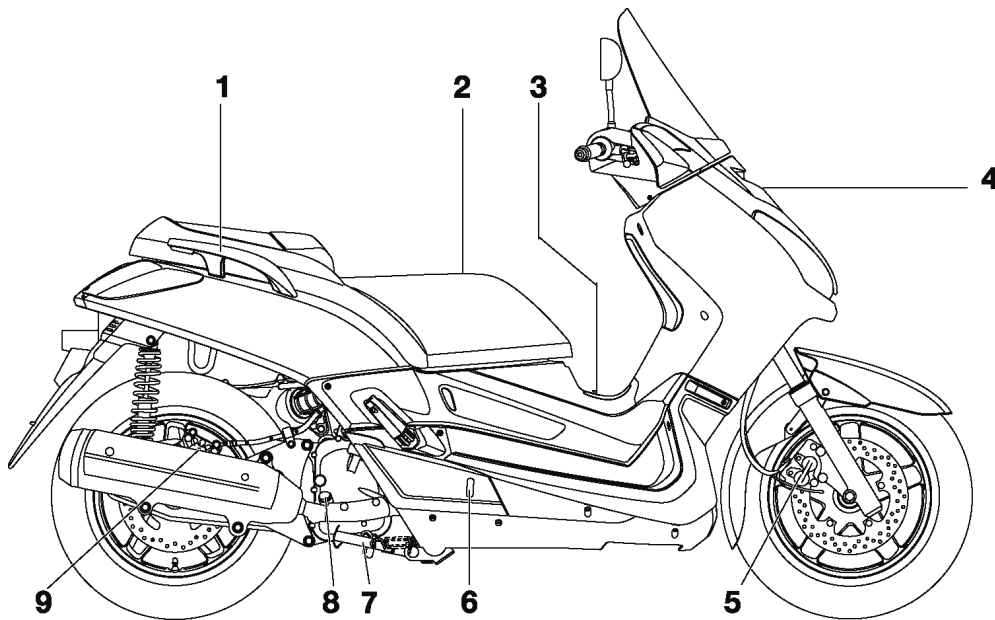

- 1. Grab bar (page 5-2)
- 2. Seat (page 3-14)
- 3. Fuel tank cap (page 3-11)
- 4. Fuses (page 6-26)
- 5. Front brake pads (page 6-19)
- 6. Coolant level check window (page 6-13)
- 7. Centerstand (page 6-22)
- 8. Engine oil filler cap (page 6-9)

- 9. Rear brake pads (page 6-19)

2-2

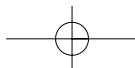

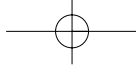

DESCRIPTION

EAU10430

Controls and instruments

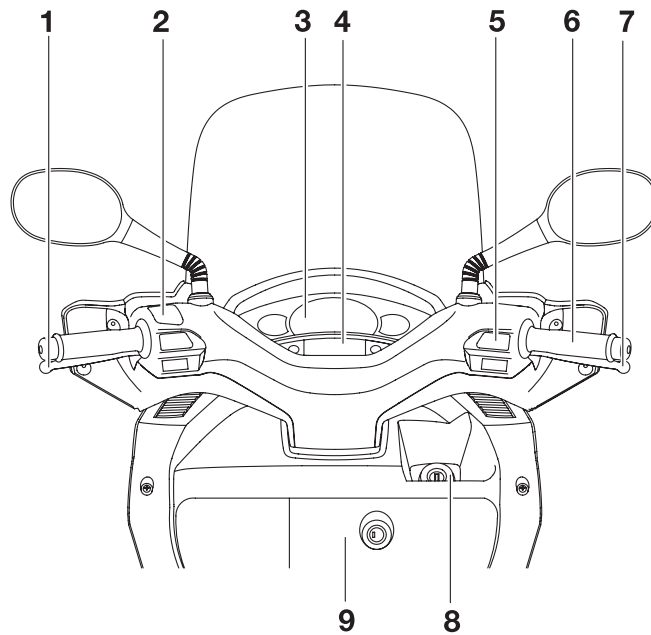

1. Rear brake lever (page 3-10)
2. Left handlebar switches (page 3-9)
3. Speedometer (page 3-5)
4. Multi-function display (page 3-6)
5. Right handlebar switches (page 3-9)
6. Throttle grip (page 6-15)
7. Front brake lever (page 3-10)
8. Main switch/steering lock (page 3-2)

9. Front storage compartment (page 3-16)

2-3

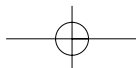

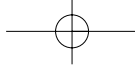

INSTRUMENT AND CONTROL FUNCTIONS

Immobilizer system

EAU10974

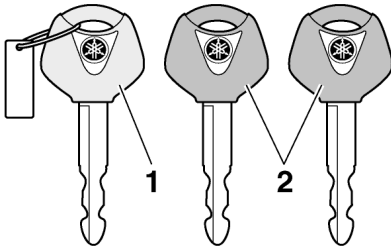

1. Code re-registering key (red bow)
2. Standard keys (black bow)

This vehicle is equipped with an immobilizer system to help prevent theft by re-registering codes in the standard keys. This system consists of the following.

- a code re-registering key (with a red bow)
- two standard keys (with a black bow) that can be re-registered with new codes
- a transponder (which is installed in the code re-registering key)
- an immobilizer unit
- an ECU (Electronic Control Unit)

- an immobilizer system indicator light (See page 3-3).

The key with the red bow is used to register codes in each standard key. Since re-registering is a difficult process, take the vehicle along with all three keys to a Yamaha dealer to have them re-registered. Do not use the key with the red bow for driving. It should only be used for re-registering the standard keys. Always use a standard key for driving.

ECA11821

NOTICE

- **DO NOT LOSE THE CODE RE-REGISTERING KEY! CONTACT YOUR DEALER IMMEDIATELY IF IT IS LOST!** If the code re-registering key is lost, registering new codes in the standard keys is impossible. The standard keys can still be used to start the vehicle, however if code re-registering is required (i.e., if a new standard key is made or all keys are lost) the entire immobilizer system must be replaced. Therefore, it is highly recommended to use

either standard key and keep the code re-registering key in a safe place.

- Do not submerge any key in water.
- Do not expose any key to excessively high temperatures.
- Do not place any key close to magnets (this includes, but not limited to, products such as speakers, etc.).
- Do not place items that transmit electrical signals close to any key.
- Do not place heavy items on any key.
- Do not grind any key or alter its shape.
- Do not disassemble the plastic part of any key.
- Do not put two keys of any immobilizer system on the same key ring.
- Keep the standard keys as well as keys of other immobilizer systems away from this vehicle's code re-registering key.

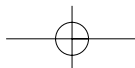

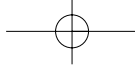

INSTRUMENT AND CONTROL FUNCTIONS

- Keep other immobilizer system keys away from the main switch as they may cause signal interference.

Main switch/steering lock

EAU10471

EAU34121

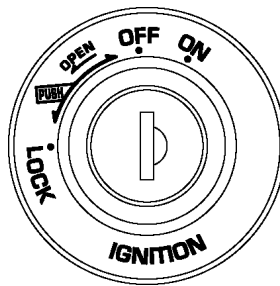

The main switch/steering lock controls the ignition and lighting systems, and is used to lock the steering.

TIP

Be sure to use the standard key (black bow) for regular use of the vehicle. To minimize the risk of losing the code re-registering key (red bow), keep it in a safe place and only use it for code re-registering.

ON

All electrical circuits are supplied with power; the meter lighting, taillight, license plate light and auxiliary lights come on, and the engine can be started. The key cannot be removed.

TIP

The headlights come on automatically when the engine is started and stay on until the key is turned to "OFF" or the sidestand is moved down.

3

EAU10661

OFF

All electrical systems are off. The key can be removed.

EWA10061

WARNING

Never turn the key to "OFF" or "LOCK" while the vehicle is moving. Otherwise the electrical systems will be switched off, which may result in loss of control or an accident.



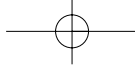

INSTRUMENT AND CONTROL FUNCTIONS

LOCK

The steering is locked, and all electrical systems are off. The key can be removed.

To lock the steering

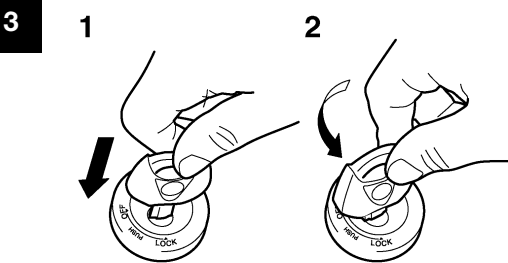

1. Push.
2. Turn.

1. Turn the handlebars all the way to the left.
2. Push the key in from the "OFF" position, and then turn it to "LOCK" while still pushing it.
3. Remove the key.

EAU10681

To unlock the steering

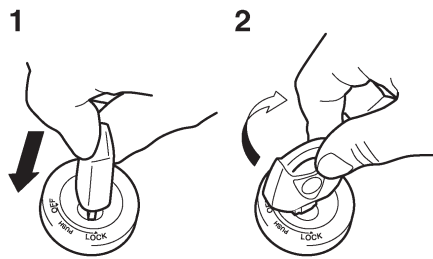

1. Push.
2. Turn.

Push the key in, and then turn it to "OFF" while still pushing it.

Indicator and warning lights

EAU11003

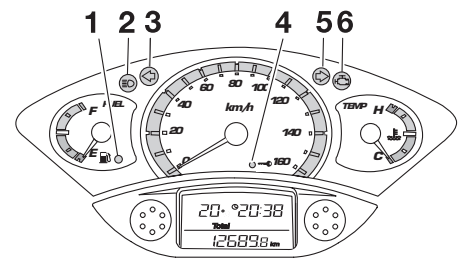

1. Fuel level warning light "⛽"
2. High beam indicator light "≡"
3. Left turn signal indicator light "↶"
4. Immobilizer system indicator light "🔑"
5. Right turn signal indicator light "↷"
6. Engine trouble warning light "🔧"

Turn signal indicator lights "↶" and "↷"

The corresponding indicator light flashes when the turn signal switch is pushed to the left or right.

EAU11030

High beam indicator light "≡"

This indicator light comes on when the high beam of the headlight is switched on.

EAU11080

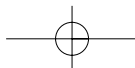

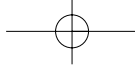

INSTRUMENT AND CONTROL FUNCTIONS

Fuel level warning light “ ”

EAU11350

This warning light comes on when the fuel level drops below approximately 2 L (0.53 US gal) (0.44 Imp.gal). When this occurs, refuel as soon as possible.

The electrical circuit of the warning light can be checked by turning the key to “ON”.

If the warning light does not come on for a few seconds, then go off, have a Yamaha dealer check the electrical circuit.

Engine trouble warning light “ ”

EAUT1932

This warning light flashes or stays on if an electrical circuit monitoring the engine is not working correctly. If this occurs, have a Yamaha dealer check the self-diagnosis system.

The electrical circuit of the warning light can be checked by turning the key to “ON”. If the warning light does not come on for a few seconds, then go off, have a Yamaha dealer check the electrical circuit.

Immobilizer system indicator light “ ”

EAU27021

The electrical circuit of the indicator light can be checked by turning the key to “ON”.

If the indicator light does not come on for a few seconds, then go off, have a Yamaha dealer check the electrical circuit.

When the key is turned to “OFF” and 30 seconds have passed, the indicator light will start flashing indicating the immobilizer system is enabled. After 24 hours have passed, the indicator light will stop flashing, however the immobilizer system is still enabled.

TIP

This model is also equipped with a self-diagnosis device for the immobilizer system. If the immobilizer system is not working correctly, the indicator light will start flashing a pattern when the key is turned to “ON”. When this occurs, have a Yamaha dealer check the self-diagnosis system. However, if the indicator light slowly flashes five

times, and then quickly flashes two times repeatedly, this error could be caused by signal interference. If this occurs, try the following.

1. Use the code re-registering key to start the engine.

TIP

Make sure there are no other immobilizer keys close to the main switch, and do not keep more than one immobilizer key on the same key ring! Immobilizer system keys may cause signal interference, which may prevent the engine from starting.

2. If the engine starts, turn it off, and try starting the engine with the standard keys.
3. If one or both of the standard keys do not start the engine, take the vehicle, the code re-registering key and both standard keys to a Yamaha dealer and have the standard keys re-registered.



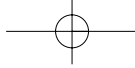

INSTRUMENT AND CONTROL FUNCTIONS

Speedometer

EAU11591

EAUM1471

EAU12172

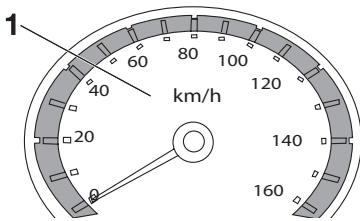

1. Speedometer

UK ONLY

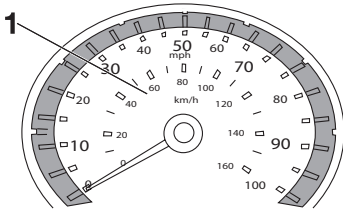

1. Speedometer

The speedometer shows the riding speed.

Fuel gauge

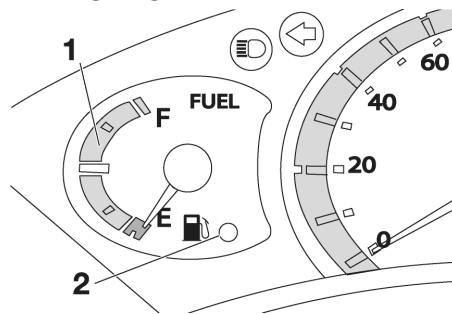

1. Fuel gauge
2. Fuel level warning light

The fuel gauge indicates the amount of fuel in the fuel tank. The needle moves towards “E” (Empty) as the fuel level decreases. When the remaining fuel in the tank reaches approximately 2 L (0.53 US gal) (0.44 Imp.gal), the fuel level warning light will come on and the multi-function display will automatically change to the “Trip/fuel” mode. (See page 3-6). If this occurs, refuel as soon as possible.

TIP

Do not allow the fuel tank to empty itself completely.

Coolant temperature gauge

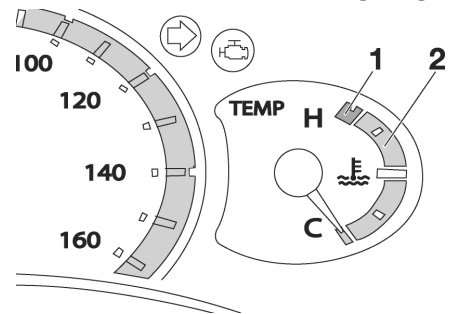

1. Coolant temperature gauge red zone
2. Coolant temperature gauge

With the key in the “ON” position, the coolant temperature gauge indicates the temperature of the coolant. The coolant temperature varies with changes in the weather and engine load. If the needle reaches or enters the red zone, stop the vehicle and let the engine cool. (See page 6-34).

ECA10021

NOTICE

Do not continue to operate the engine if it is overheating.

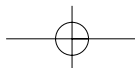

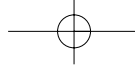

INSTRUMENT AND CONTROL FUNCTIONS

Multi-function display

EAUM2252

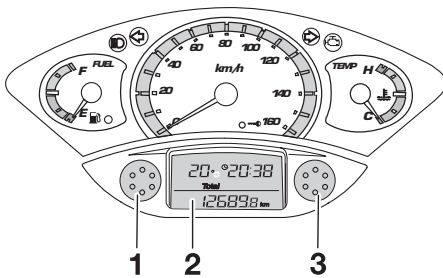

1. "MODE" button
2. Multi-function display
3. "SET" button

WARNING

Be sure to stop the vehicle before making any setting changes to the multi-function display. Changing settings while riding can distract the operator and increase the risk of an accident.

The multi-function display is equipped with the following:

- an odometer (which shows the total distance traveled)
- two tripmeters (which show the distance traveled since they were

last set to zero, the time passed since the tripmeters were set to zero, and the average speed traveled during this time)

- a fuel reserve tripmeter (which shows the distance traveled since the fuel level warning light came on)
- a clock
- an ambient temperature display
- an oil change indicator (which comes on when the engine oil should be changed)

TIP

- For the UK, the distance traveled is displayed in miles and the temperature reading is displayed in °F.
- For other countries, the distance traveled is displayed in kilometers and the temperature reading is displayed in °C.

Odometer and tripmeter modes

Pushing the "MODE" button switches the display between the odometer mode "Total" and the tripmeter modes "Trip" in the following order:

Total → Trip 1 → Trip 2 → Trip/fuel → Total

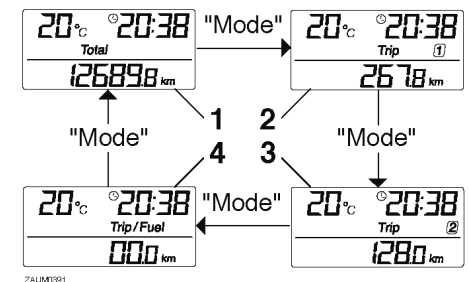

1. Total
2. Trip 1
3. Trip 2
4. Trip/Fuel

TIP

The Trip/fuel odometer is only activated if the fuel level warning light comes on.

Pushing the "SET" button when in the tripmeter mode switches the display between the different tripmeter functions in the following order:

Trip 1 or Trip 2 → Time 1 or 2 → Average speed 1 or 2 → Trip 1 or Trip 2

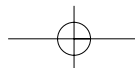

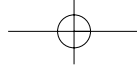

INSTRUMENT AND CONTROL FUNCTIONS

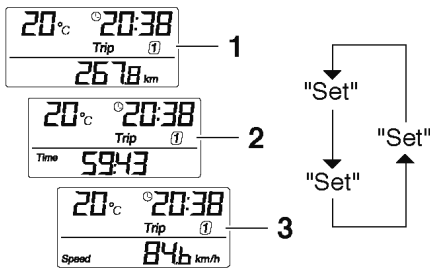

ZAUM0392

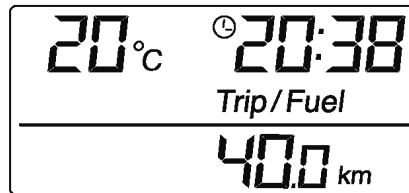

ZAUM0393

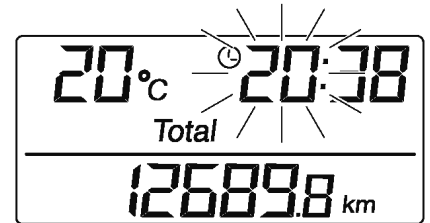

ZAUM0394

3

1. Distance
2. Time
3. Average speed

If the fuel level warning light comes on (See page 3-5), the display will automatically change to the fuel reserve tripmeter mode "Trip/fuel" and start counting the distance traveled from that point. In that case, pushing the "MODE" button switches the display between the various tripmeter and odometer modes in the following order:

Trip/Fuel → Trip 1 → Trip 2 → Total → Trip/fuel

To reset a tripmeter, select it by pushing the "MODE" button, and then push the "SET" button for at least one second. If you do not reset the fuel reserve tripmeter manually, it will reset itself automatically and the display will return to the prior mode after refueling and traveling 5 km (3 mi).

Clock mode

To set the clock:

1. When the display is in the "Total" mode, push the "SET" button for at least two seconds.
2. When the hour digits start flashing, push the "SET" button to set the hours.

3. Push the "MODE" button, and the minute digits will start flashing.
4. Push the "SET" button to set the minutes.
5. Push the "MODE" button and then release it to start the clock. The display will return to the "Total" mode.

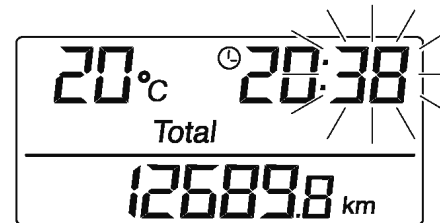

ZAUM0395

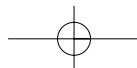

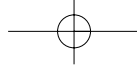

INSTRUMENT AND CONTROL FUNCTIONS

Ambient temperature display

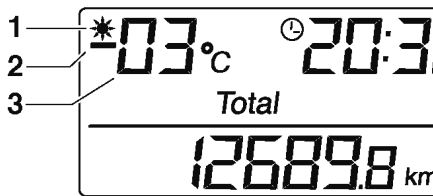

ZAU0396

1. Frost warning indicator “❄”
2. Minus item
3. Temperature

This display shows the ambient temperature from $-30\text{ }^{\circ}\text{C}$ ($-86\text{ }^{\circ}\text{F}$) to $50\text{ }^{\circ}\text{C}$ ($122\text{ }^{\circ}\text{F}$).

The frost warning indicator “❄” automatically comes on if the temperature is lower than $3\text{ }^{\circ}\text{C}$ ($37\text{ }^{\circ}\text{F}$).

Oil change indicator “OIL”

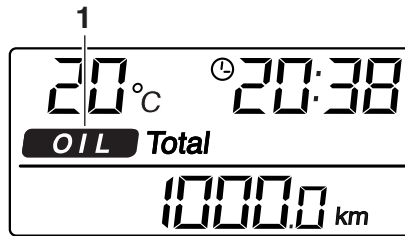

ZAU0582

1. Oil change indicator “OIL”

The engine oil should be changed when this indicator comes on. The indicator stays on until it is reset. After changing the engine oil, reset the indicator as follows.

1. While holding the “MODE” and “SET” buttons pushed, turn the key to “ON”.
2. Continue holding the “MODE” and “SET” buttons pushed for two to five seconds.
3. Release the buttons and the oil change indicator will go off.

TIP

- The oil change indicator will come on at the initial 1000 km (600 mi), 5000 km (3000 mi) after the initial 1000 km (600 mi) and every 6000 km (3600 mi) thereafter.
- If the engine oil is changed before the oil change indicator comes on (i.e. before the periodic oil change interval has been reached), the indicator must be reset after the oil change for the next periodic oil change to be indicated at the correct time. After resetting, the indicator will come on for two seconds. If the indicator does not come on, repeat the procedure.

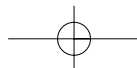

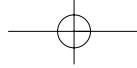

INSTRUMENT AND CONTROL FUNCTIONS

EAU12331

Anti-theft alarm (optional)

This model can be equipped with an optional anti-theft alarm by a Yamaha dealer. Contact a Yamaha dealer for more information.

Handlebar switches

Left

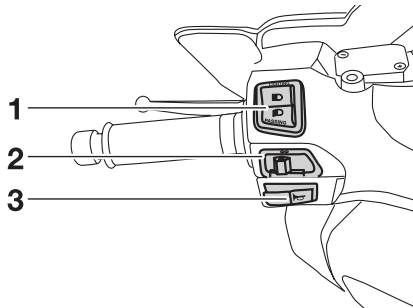

1. Dimmer “ / ”/Pass “” switch
2. Turn signal switch “ / ”
3. Horn switch “”

Right

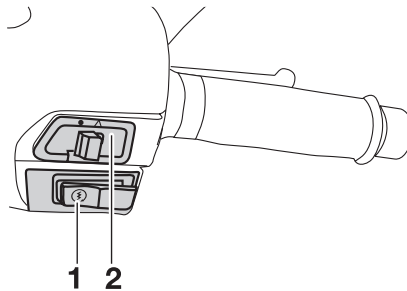

1. Start switch “”
2. Hazard switch “”

3-9

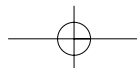

EAU12347

Dimmer switch “ / ”

Set this switch to “” for the high beam and to “” for the low beam. With the headlight on low beam, press this switch downwards to flash the headlight.

EAUS1020

EAU12460

Turn signal switch “ / ”

To signal a right-hand turn, push this switch to “”. To signal a left-hand turn, push this switch to “”. When released, the switch returns to the center position. To cancel the turn signal lights, push the switch in after it has returned to the center position.

EAU12500

Horn switch “”

Press this switch to sound the horn.

EAU12721

Start switch “”

With the sidestand up, push this switch while applying the front or rear brake to crank the engine with the starter. See page 5-1 for starting instructions prior to starting the engine.

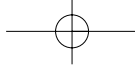

INSTRUMENT AND CONTROL FUNCTIONS

Hazard switch “⊙”, “▲”

EAU1990

With the key in the “ON” position, set this switch to “▲” to turn on the hazard lighting (simultaneous flashing of all turn signal lights). To turn off the hazard lighting, set this switch to “⊙” and, then turn the key to “OFF”.

TIP

Even if the key is turned from “ON” to “OFF” with the hazard lighting on, the hazard lighting will continue to flash regardless of the hazard switch position. To cancel the hazard lighting, the key must be turned to “ON” and the hazard switch must be set to the “⊙” position.

The hazard lighting is used in case of an emergency or to warn other drivers when your scooter is stopped where it might be a traffic hazard.

ECA10060

NOTICE

Do not use the hazard light for an extended length of time, otherwise the battery may discharge.

Front brake lever

EAU12900

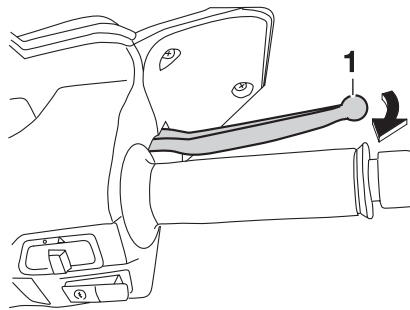

1. Front brake lever

The front brake lever is located on the right handlebar grip. To apply the front brake, pull this lever toward the handlebar grip.

Rear brake lever

EAU12950

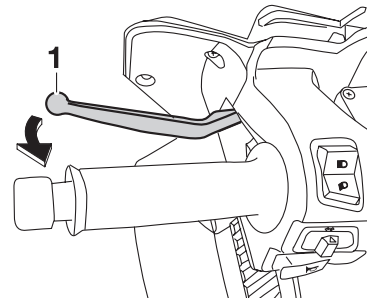

1. Rear brake lever

The rear brake lever is located on the left handlebar grip. To apply the rear brake, pull this lever toward the handlebar grip.

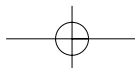

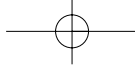

INSTRUMENT AND CONTROL FUNCTIONS

EAU13175

Fuel tank cap

To remove the fuel tank cap

1. Open the lid by pulling the lever up.

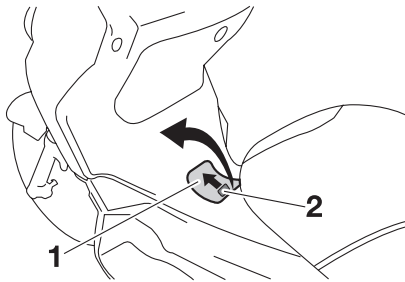

1. Fuel tank cap lid
2. Lever

2. Insert the key into the lock and turn it clockwise. The lock will be released and the fuel tank cap can be removed.

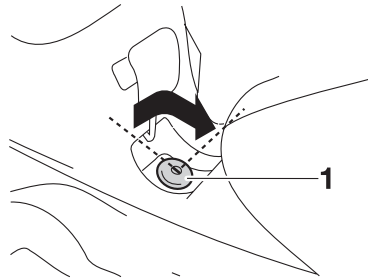

1. Fuel tank cap

To install the fuel tank cap

1. Align the match marks, insert the fuel tank cap into the tank opening, and then push down on the cap.

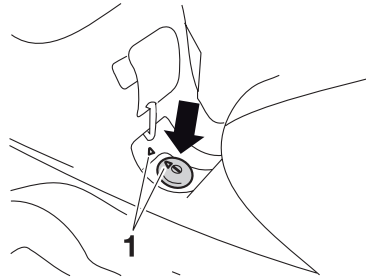

1. Match marks

2. Turn the key counterclockwise to the original position, and then remove it.
3. Close the lid.

EWA11261

WARNING

Make sure that the fuel tank cap is properly installed and locked in place before riding the scooter. Leaking fuel is a fire hazard.

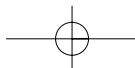

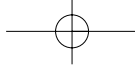

INSTRUMENT AND CONTROL FUNCTIONS

Fuel

Make sure there is sufficient gasoline in the tank.

EAU13212

EWA10881

WARNING

Gasoline and gasoline vapors are extremely flammable. To avoid fires and explosions and to reduce the risk of injury when refueling, follow these instructions.

1. Before refueling, turn off the engine and be sure that no one is sitting on the vehicle. Never refuel while smoking, or while in the vicinity of sparks, open flames, or other sources of ignition such as the pilot lights of water heaters and clothes dryers.
2. Do not overfill the fuel tank. Stop filling when the fuel reaches the bottom of the filler tube. Because fuel expands when it heats up, heat from the engine or the sun can cause fuel to spill out of the fuel tank.

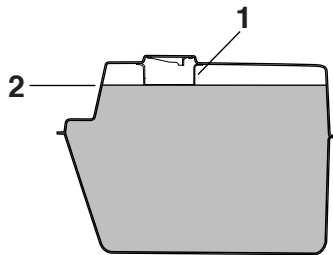

ZAUM0020

1. Fuel tank filler tube
2. Fuel level

3. Wipe up any spilled fuel immediately. **NOTICE: Immediately wipe off spilled fuel with a clean, dry, soft cloth, since fuel may deteriorate painted surfaces or plastic parts.** [ECA10071]

4. Be sure to securely close the fuel tank cap.

EWA15151

WARNING

Gasoline is poisonous and can cause injury or death. Handle gasoline with care. Never siphon gasoline by mouth. If you should swallow some gasoline or inhale a lot of gasoline vapor, or get some gasoline in your eyes, see your doctor immediately.

3-12

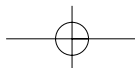

If gasoline spills on your skin, wash with soap and water. If gasoline spills on your clothing, change your clothes.

EAU13390

Recommended fuel:
PREMIUM UNLEADED
GASOLINE ONLY
Fuel tank capacity:
12.5 L (3.30 US gal, 2.75 Imp.gal)
Fuel reserve amount (when the fuel level warning light comes on):
2 L (0.53 US gal) (0.44 Imp.gal)

3

ECA11400

NOTICE

Use only unleaded gasoline. The use of leaded gasoline will cause severe damage to internal engine parts, such as the valves and piston rings, as well as to the exhaust system.

Your Yamaha engine has been designed to use premium unleaded gasoline with a research octane number of 95 or higher. If knocking (or pinging) occurs, use a gasoline of a different

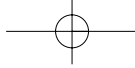

INSTRUMENT AND CONTROL FUNCTIONS

brand. Use of unleaded fuel will extend spark plug life and reduce maintenance costs.

EAU13445

ECA10701

Catalytic converters

This vehicle is equipped with catalytic converters in the exhaust system.

EWA10862

WARNING

The exhaust system is hot after operation. To prevent a fire hazard or burns:

- Do not park the vehicle near possible fire hazards such as grass or other materials that easily burn.
- Park the vehicle in a place where pedestrians or children are not likely to touch the hot exhaust system.
- Make sure that the exhaust system has cooled down before doing any maintenance work.
- Do not allow the engine to idle more than a few minutes. Long idling can cause a build-up of heat.

NOTICE

Use only unleaded gasoline. The use of leaded gasoline will cause unrepairable damage to the catalytic converter.

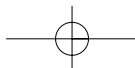

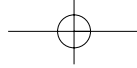

INSTRUMENT AND CONTROL FUNCTIONS

Securing bracket

EAUT1040

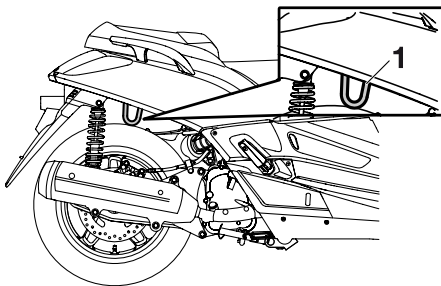

1. Securing bracket

To prevent theft, the securing bracket can be used to chain the scooter to a stationary object such as a lamppost or a fence.

To secure the scooter with a chain or cable lock, place the scooter on the centerstand, pass the chain or cable through the securing bracket and around the stationary object, and then lock the chain or cable lock.

WARNING

Be sure to remove the chain or cable before riding, otherwise the scooter may overturn, causing damage or injury.

EWAT1020

Seat

To open the seat

1. Place the scooter on the centerstand.
2. Insert the key into the main switch, and then turn it counter-clockwise to "OPEN".

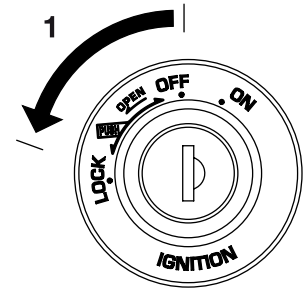

1. Open.

TIP

Do not push inward when turning the key.

3. Fold the seat up.

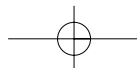

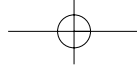

INSTRUMENT AND CONTROL FUNCTIONS

3

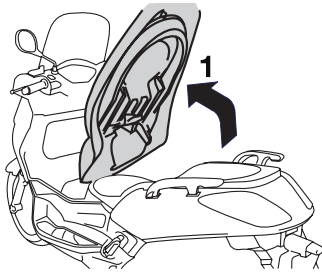

1. Seat open position

To close the seat

1. Fold the seat down, and then push it down to lock it in place.
2. Remove the key from the main switch if the scooter will be left unattended.

TIP

Make sure that the seat is properly secured before riding.

Storage compartments

Front storage compartment

EAUT1712

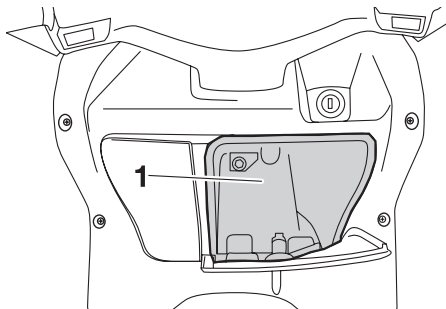

1. Front storage compartment

WARNING

EWA11191

- Do not exceed the load limit of 1 kg (2.2 lb) for the front storage compartment.
- Do not exceed the maximum load of 189 kg (417 lb) for the vehicle.

Rear storage compartment

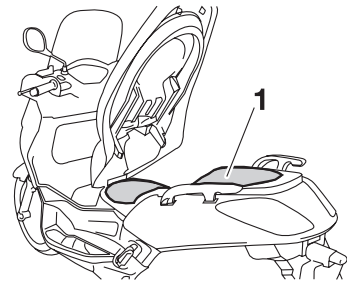

1. Rear storage compartment

The rear storage compartment is located under the seat. (See page 3-14).

ECAT1030

NOTICE

Keep the following points in mind when using the storage compartment.

- Since the storage compartment accumulates heat when exposed to the sun, do not store anything susceptible to heat inside it.
- To avoid humidity from spreading through the storage compartment, wrap wet articles in

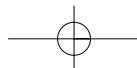

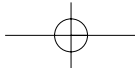

INSTRUMENT AND CONTROL FUNCTIONS

a plastic bag before storing them in the compartment.

- Since the storage compartment may get wet while the scooter is being washed, wrap any articles stored in the compartment in a plastic bag.
- Do not keep anything valuable or breakable in the storage compartment.

EWAT1051

WARNING

- Do not exceed the load limit of 5 kg (11 lb) for the rear storage compartment.
- Do not exceed the maximum load of 189 kg (417 lb) for the vehicle.

Front storage compartment

To open the storage compartment

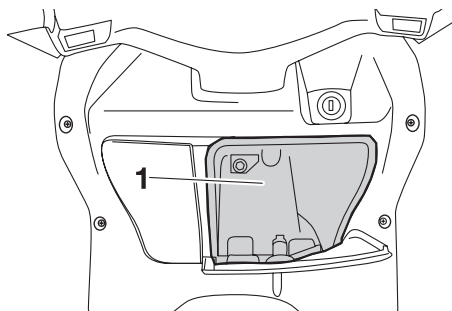

1. Front storage compartment

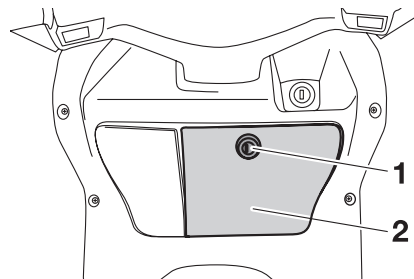

1. Lock.
2. Front storage compartment

EAU14541

Insert the key into the lock, turn it clockwise, and then pull on it to open the storage compartment lid.

To close the storage compartment

Push the storage compartment lid into the original position, and then remove the key.

EWA10961

WARNING

- Do not exceed the load limit of 1 kg (2.2 lb) for the storage compartment.
- Do not exceed the maximum load of 189 kg (417 lb) for the vehicle.

3

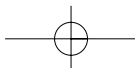

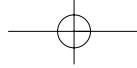

INSTRUMENT AND CONTROL FUNCTIONS

EAUT1060

ECA10080

Rear storage compartment

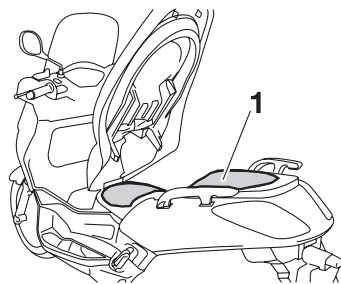

1. Rear storage compartment

There is a storage compartment under the seat.

EWA10960

WARNING

- Do not exceed the load limit of 5 kg (11 lb) for the storage compartment.
- Do not exceed the maximum load of 189 kg (417 lb) for the vehicle.

NOTICE

Keep the following points in mind when using the storage compartment.

- Since the storage compartment accumulates heat when exposed to the sun, do not store anything susceptible to heat inside it.
- To avoid humidity from spreading through the storage compartment, wrap wet articles in a plastic bag before storing them in the compartment.
- Since the storage compartment may get wet while the scooter is being washed, wrap any articles stored in the compartment in a plastic bag.
- Do not keep anything valuable or breakable in the storage compartment.

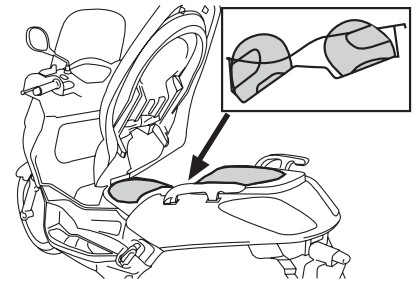

To store two helmets in the storage compartment, place the helmets as shown.

TIP

- Some helmets cannot be stored in the storage compartment because of their size or shape.
- Do not leave your scooter unattended with the seat open.

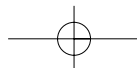

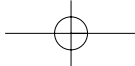

INSTRUMENT AND CONTROL FUNCTIONS

Adjusting the shock absorber assemblies

EAU14881

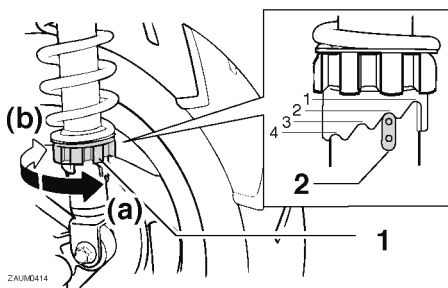

- 1. Spring preload adjusting ring
- 2. Position indicator

Each shock absorber assembly is equipped with a spring preload adjusting ring.

ECA10101

NOTICE

To avoid damaging the mechanism, do not attempt to turn beyond the maximum or minimum settings.

WARNING

Always adjust both shock absorber assemblies equally, otherwise poor handling and loss of stability may result.

Adjust the spring preload as follows. To increase the spring preload and thereby harden the suspension, turn the adjusting ring on each shock absorber assembly in direction (a). To decrease the spring preload and thereby soften the suspension, turn the adjusting ring on each shock absorber assembly in direction (b).

Align the appropriate notch in the adjusting ring with the position indicator on the shock absorber.

Spring preload setting:

Minimum (soft):

1

Standard:

1

Maximum (hard):

4

Sidestand

EWA10210

EAU15301

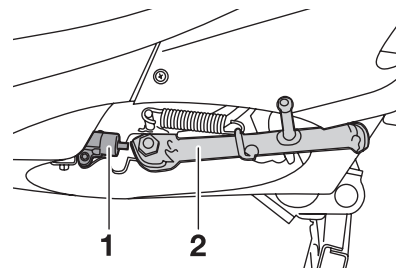

- 1. Sidestand switch
- 2. Sidestand

The sidestand is located on the left side of the frame. Raise the sidestand or lower it with your foot while holding the vehicle upright.

TIP

The built-in sidestand switch is part of the ignition circuit cut-off system, which cuts the ignition in certain situations. (See further down for an explanation of the ignition circuit cut-off system.)

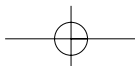

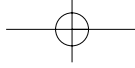

INSTRUMENT AND CONTROL FUNCTIONS

WARNING

EWA10240

EAU45051

The vehicle must not be ridden with the sidestand down, or if the sidestand cannot be properly moved up (or does not stay up), otherwise the sidestand could contact the ground and distract the operator, resulting in a possible loss of control. Yamaha's ignition circuit cut-off system has been designed to assist the operator in fulfilling the responsibility of raising the sidestand before starting off. Therefore, check this system regularly as described below and have a Yamaha dealer repair it if it does not function properly.

Ignition circuit cut-off system

The ignition circuit cut-off system (comprising the sidestand switch and brake light switches) has the following functions.

- It prevents starting when the sidestand is up, but neither brake is applied.
- It prevents starting when either brake is applied, but the sidestand is still down.
- It cuts the running engine when the sidestand is moved down.

Periodically check the operation of the ignition circuit cut-off system according to the following procedure.

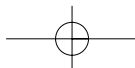

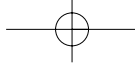

INSTRUMENT AND CONTROL FUNCTIONS

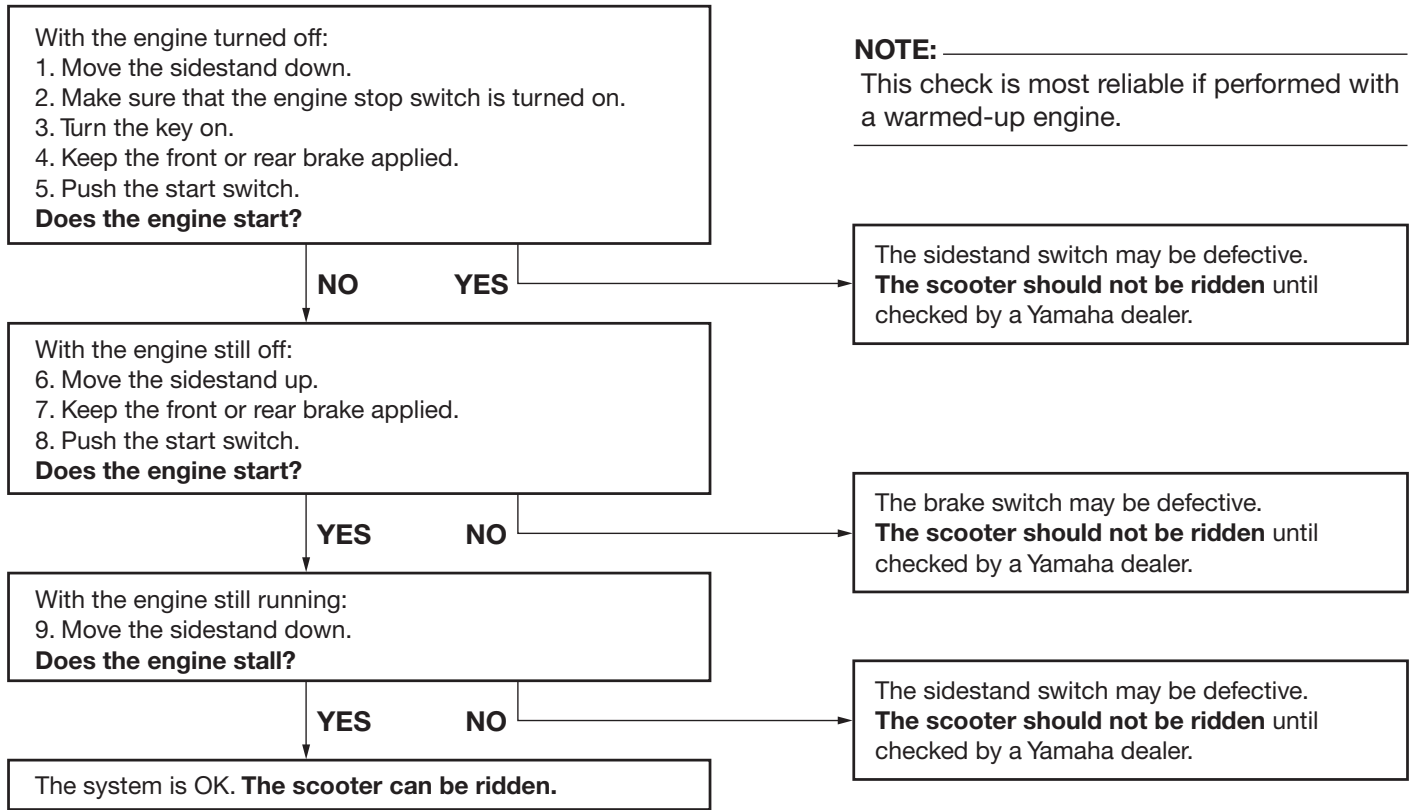

3

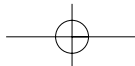

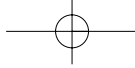

FOR YOUR SAFETY – PRE-OPERATION CHECKS

EAU15596

Inspect your vehicle each time you use it to make sure the vehicle is in safe operating condition. Always follow the inspection and maintenance procedures and schedules described in the Owner's Manual.

EWA11151

⚠ WARNING

Failure to inspect or maintain the vehicle properly increases the possibility of an accident or equipment damage. Do not operate the vehicle if you find any problem. If a problem cannot be corrected by the procedures provided in this manual, have the vehicle inspected by a Yamaha dealer.

Before using this vehicle, check the following points:

4

ITEM	CHECKS	PAGE
Fuel	<ul style="list-style-type: none"> • Check fuel level in fuel tank. • Refuel if necessary. • Check fuel line for leakage. 	3-12
Engine oil	<ul style="list-style-type: none"> • Check oil level in engine. • If necessary, add recommended oil to specified level. • Check vehicle for oil leakage. 	6-9
Final transmission oil	<ul style="list-style-type: none"> • Check vehicle for oil leakage. 	6-12
Coolant	<ul style="list-style-type: none"> • Check coolant level in reservoir. • If necessary, add recommended coolant to specified level. • Check cooling system for leakage. 	6-13
Front brake	<ul style="list-style-type: none"> • Check operation. • If soft or spongy, have Yamaha dealer bleed hydraulic system. • Check lever free play. • Adjust if necessary. • Check brake pads for wear. • Replace if necessary. • Check fluid level in reservoir. • If necessary, add recommended brake fluid to specified level. • Check hydraulic system for leakage. 	6-19, 6-20

4-1



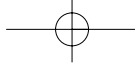

FOR YOUR SAFETY – PRE-OPERATION CHECKS

ITEM	CHECKS	PAGE
Rear brake	<ul style="list-style-type: none"> • Check operation. • If soft or spongy, have Yamaha dealer bleed hydraulic system. • Check brake pads for wear. • Replace if necessary. • Check fluid level in reservoir. • If necessary, add recommended brake fluid to specified level. • Check hydraulic system for leakage. 	6-19, 6-20
Throttle grip	<ul style="list-style-type: none"> • Make sure that operation is smooth. • Check cable free play. • If necessary, have Yamaha dealer adjust cable free play and lubricate cable and grip housing. 	6-22
Wheels and tires	<ul style="list-style-type: none"> • Check for damage. • Check tire condition and tread depth. • Check air pressure. • Correct if necessary. 	6-16, 6-18
Brake levers	<ul style="list-style-type: none"> • Make sure that operation is smooth. • Lubricate lever pivoting points if necessary. 	6-22
Centerstand, sidestand	<ul style="list-style-type: none"> • Make sure that operation is smooth. • Lubricate pivots if necessary. 	6-22
Chassis fasteners	<ul style="list-style-type: none"> • Make sure that all nuts, bolts and screws are properly tightened. • Tighten if necessary. 	—
Instruments, lights, signals and switches	<ul style="list-style-type: none"> • Check operation. • Correct if necessary. 	—
Sidestand switch	<ul style="list-style-type: none"> • Check operation of ignition circuit cut-off system. • If system is not working correctly, have Yamaha dealer check vehicle. 	3-18

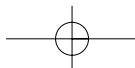

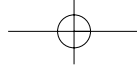

OPERATION AND IMPORTANT RIDING POINTS

Read the Owner's Manual carefully to become familiar with all controls. If there is a control or function you do not understand, ask your Yamaha dealer.

EAU15951

EAU45310

EAUM2231

WARNING

EWA10271

Failure to familiarize yourself with the controls can lead to loss of control, which could cause an accident or injury.

TIP

This model is equipped with a lean angle sensor to stop the engine in case of a turnover. To start the engine after a turnover, be sure to turn the main switch to "OFF" and then to "ON". Failing to do so will prevent the engine from starting even though the engine will crank when pushing the start switch.

Starting the engine

NOTICE

See page 5-4 for engine break-in instructions prior to operating the vehicle for the first time.

ECA10250

In order for the ignition circuit cut-off system to enable starting, the sidestand must be up.

See page 3-19 for more information.

1. Turn the key to "ON".

The following warning lights and indicator light should come on for a few seconds, then go off.

- Fuel level warning light
- Engine trouble warning light
- Immobilizer system indicator light

ECA11831

NOTICE

If a warning or indicator light does not go off, see page 3-3 for the corresponding warning and indicator light circuit check.

2. Close the throttle completely.

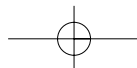

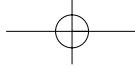

OPERATION AND IMPORTANT RIDING POINTS

3. Start the engine by pushing the start switch while applying the front or rear brake. **NOTICE: For maximum engine life, never accelerate hard when the engine is cold!** [ECA11041]

If the engine does not start, release the start switch, wait a few seconds, and then try again. Each starting attempt should be as short as possible to preserve the battery. Do not crank the engine more than 10 seconds on any one attempt. If the engine does not start, try with the throttle open 1/8 turn.

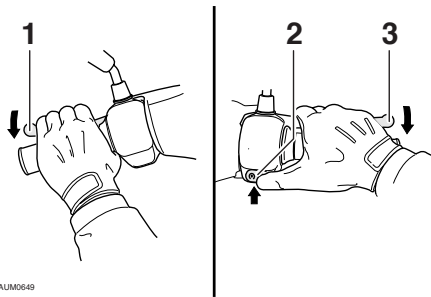

1. Rear brake lever
2. Start switch
3. Front brake lever

ZAUM0649

Starting off

EAU16761

TIP

Before starting off, allow the engine to warm up.

1. While pulling the rear brake lever with your left hand and holding the grab bar with your right hand, push the scooter off the centerstand.

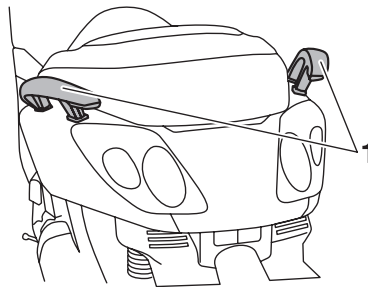

1. Grab bar

2. Sit astride the seat, and then adjust the rear view mirrors.
3. Switch the turn signals on.

4. Check for oncoming traffic, and then slowly turn the throttle grip (on the right) in order to take off.
5. Switch the turn signals off.

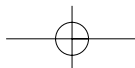

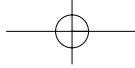

OPERATION AND IMPORTANT RIDING POINTS

Acceleration and deceleration

EAU16780

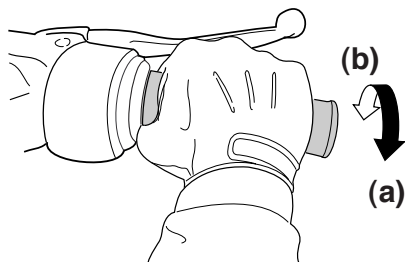

ZAJUM0199

5

The speed can be adjusted by opening and closing the throttle. To increase the speed, turn the throttle grip in direction (a). To reduce the speed, turn the throttle grip in direction (b).

Braking

EAU16793

EWA10300

⚠ WARNING

- Avoid braking hard or suddenly (especially when leaning over to one side), otherwise the scooter may skid or overturn.
- Railroad crossings, streetcar rails, iron plates on road construction sites, and manhole covers become extremely slippery when wet. Therefore, slow down when approaching such areas and cross them with caution.
- Keep in mind that braking on a wet road is much more difficult.
- Ride slowly down a hill, as braking downhill can be very difficult.

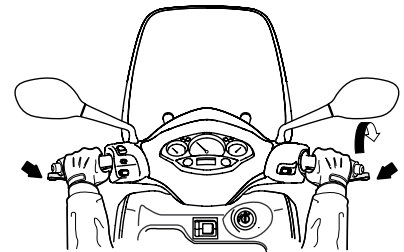

ZAJUM0551

1. Close the throttle completely.
2. Apply both front and rear brakes simultaneously while gradually increasing the pressure.



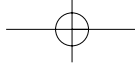

OPERATION AND IMPORTANT RIDING POINTS

Tips for reducing fuel consumption

Fuel consumption depends largely on your riding style. Consider the following tips to reduce fuel consumption:

- Avoid high engine speeds during acceleration.
- Avoid high engine speeds with no load on the engine.
- Turn the engine off instead of letting it idle for an extended length of time (e.g., in traffic jams, at traffic lights or at railroad crossings).

EAU16820

Engine break-in

There is never a more important period in the life of your engine than the period between 0 and 1000 km (600 mi). For this reason, you should read the following material carefully. Since the engine is brand new, do not put an excessive load on it for the first 1000 km (600 mi). The various parts in the engine wear and polish themselves to the correct operating clearances. During this period, prolonged full-throttle operation or any condition that might result in engine overheating must be avoided.

EAU16830

the engine oil filter element replaced. [ECAM1091]

1000 km (600 mi) and beyond

- The vehicle can now be operated normally.

ECA10270

NOTICE

If any engine trouble should occur during the engine break-in period, immediately have a Yamaha dealer check the vehicle.

EAM2281

0–500 km (0–300 mi)

- Avoid prolonged operation above 1/3 throttle.

500–1000 km (300–600 mi)

- Avoid prolonged operation above 1/2 throttle. **NOTICE: After 1000 km (600 mi) of operation, the engine oil and final transmission oil must be changed, and**

5-4



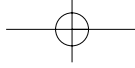

OPERATION AND IMPORTANT RIDING POINTS

EAU17213

Parking

When parking, stop the engine, and then remove the key from the main switch.

EWA10311

WARNING

- Since the engine and exhaust system can become very hot, park in a place where pedestrians or children are not likely to touch them and be burned.
- Do not park on a slope or on soft ground, otherwise the vehicle may overturn, increasing the risk of a fuel leak and fire.
- Do not park near grass or other flammable materials which might catch fire.

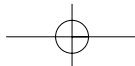

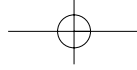

PERIODIC MAINTENANCE AND ADJUSTMENT

Periodic inspection, adjustment, and lubrication will keep your vehicle in the safest and most efficient condition possible. Safety is an obligation of the vehicle owner/operator. The most important points of vehicle inspection, adjustment, and lubrication are explained on the following pages. The intervals given in the periodic maintenance and lubrication chart should be simply considered as a general guide under normal riding conditions. However, depending on the weather, terrain, geographical location, and individual use, the maintenance intervals may need to be shortened.

EAU17281

EWA15121

EAU17521

⚠ WARNING

Turn off the engine when performing maintenance unless otherwise specified.

- A running engine has moving parts that can catch on body parts or clothing and electrical parts that can cause shocks or fires.
- Running the engine while servicing can lead to eye injury, burns, fire, or carbon monoxide poisoning – possibly leading to death. See page 1-1 for more information about carbon monoxide.

EWA10321

EWA10330

⚠ WARNING

Failure to properly maintain the vehicle or performing maintenance activities incorrectly may increase your risk of injury or death during service or while using the vehicle. If you are not familiar with vehicle service, have a Yamaha dealer perform service.

⚠ WARNING

This scooter is designed for use on paved roads only. If this scooter is operated in abnormally dusty, muddy or wet conditions, the air filter element should be cleaned or replaced more frequently, otherwise rapid engine wear may result. Consult a Yamaha dealer for proper maintenance intervals.

Owner's tool kit

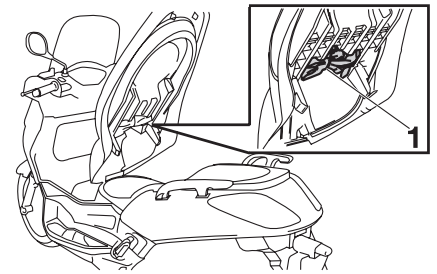

1. Owner's tool kit

The owner's tool kit is located inside the storage compartment under the seat. (See page 3-14).

The service information included in this manual and the tools provided in the owner's tool kit are intended to assist you in the performance of preventive maintenance and minor repairs. However, additional tools such as a torque wrench may be necessary to perform certain maintenance work correctly.

TIP

If you do not have the tools or experience required for a particular job, have a Yamaha dealer perform it for you.

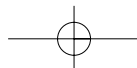

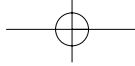

PERIODIC MAINTENANCE AND ADJUSTMENT

EAU46870

TIP

- The annual checks must be performed every year, except if a kilometer-based maintenance, or for the UK, a mileage-based maintenance, is performed instead.
- From 30000 km (17500 mi), repeat the maintenance intervals starting from 6000 km (3500 mi).
- Items marked with an asterisk should be performed by a Yamaha dealer as they require special tools, data and technical skills.

EAU46920

Periodic maintenance chart for the emission control system

NO.	ITEM	CHECK OR MAINTENANCE JOB	ODOMETER READING					ANNUAL CHECK
			1000 km (600 mi)	6000 km (3500 mi)	12000 km (7000 mi)	18000 km (10500 mi)	24000 km (14000 mi)	
1	* Fuel line	<ul style="list-style-type: none"> • Check fuel hoses for cracks or damage. 		√	√	√	√	√
2	Spark plug	<ul style="list-style-type: none"> • Check condition. • Clean and regap. 		√		√		
		<ul style="list-style-type: none"> • Replace. 			√		√	
3	* Valves	<ul style="list-style-type: none"> • Check valve clearance. • Adjust. 		√	√	√	√	
4	* Fuel injection	<ul style="list-style-type: none"> • Check engine idle speed. 	√	√	√	√	√	√
5	* Muffler and exhaust pipe	<ul style="list-style-type: none"> • Check the screw clamp(s) for looseness. 	√	√	√	√	√	

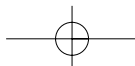

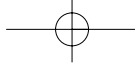

PERIODIC MAINTENANCE AND ADJUSTMENT

EAU17716

General maintenance and lubrication chart

NO.	ITEM	CHECK OR MAINTENANCE JOB	ODOMETER READING					ANNUAL CHECK
			1000 km (600 mi)	6000 km (3500 mi)	12000 km (7000 mi)	18000 km (10500 mi)	24000 km (14000 mi)	
1	* Air filter element	• Replace.			√		√	
2	* V-belt case air filter element	• Clean.		√	√	√	√	
3	* Front brake	• Check operation, fluid level and vehicle for fluid leakage.	√	√	√	√	√	√
		• Replace brake pads.	Whenever worn to the limit					
4	* Rear brake	• Check operation, fluid level and vehicle for fluid leakage.	√	√	√	√	√	√
		• Replace brake pads.	Whenever worn to the limit					
5	* Brake hoses	• Check for cracks or damage.		√	√	√	√	√
		• Replace.	Every 4 years					
6	* Wheels	• Check runout and for damage.		√	√	√	√	
7	* Tires	• Check tread depth and for damage. • Replace if necessary. • Check air pressure. • Correct if necessary.		√	√	√	√	√
8	* Wheel bearings	• Check bearing for looseness or damage.		√	√	√	√	
9	* Steering bearings	• Check bearing play and steering for roughness.	√	√	√	√	√	
		• Lubricate with lithium-soap-based grease.	Every 24000 km (14000 mi)					

6-3

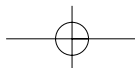

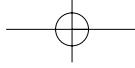

PERIODIC MAINTENANCE AND ADJUSTMENT

NO.	ITEM	CHECK OR MAINTENANCE JOB	ODOMETER READING					ANNUAL CHECK	
			1000 km (600 mi)	6000 km (3500 mi)	12000 km (7000 mi)	18000 km (10500 mi)	24000 km (14000 mi)		
10	* Chassis fasteners	• Make sure that all nuts, bolts and screws are properly tightened.		√	√	√	√	√	
11	Front brake lever pivot shaft	• Lubricate with silicone grease.		√	√	√	√	√	
12	Rear brake lever pivot shaft	• Lubricate with silicone grease.		√	√	√	√	√	
13	Sidestand, centerstand	• Check operation. • Lubricate.		√	√	√	√	√	
14	* Sidestand switch	• Check operation.	√	√	√	√	√	√	
15	* Front fork	• Check operation and for oil leakage.		√	√	√	√		
16	* Shock absorber assemblies	• Check operation and shock absorbers for oil leakage.		√	√	√	√		
17	Engine oil	• Change. (See page 6-9).	√	When the oil change indicator light comes on [5000 km (3000 mi) after the initial 1000 km (600 mi) and every 6000 km (3500 mi) thereafter]					
		• Check oil level and vehicle for oil leakage.	Every 3000 km (1800 mi)					√	
18	Engine oil filter element	• Replace.	√		√		√		
19	* Cooling system	• Check coolant level and vehicle for coolant leakage.		√	√	√	√	√	
		• Change.	Every 3 years						
20	Final transmission oil	• Check vehicle for oil leakage.	√	√		√			
		• Change.	√		√		√		

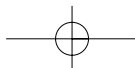

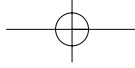

PERIODIC MAINTENANCE AND ADJUSTMENT

NO.	ITEM	CHECK OR MAINTENANCE JOB	ODOMETER READING					ANNUAL CHECK
			1000 km (600 mi)	6000 km (3500 mi)	12000 km (7000 mi)	18000 km (10500 mi)	24000 km (14000 mi)	
21	* V-belt	• Replace.	Every 18000 km (10500 mi)					
22	* Front and rear brake switches	• Check operation.	√	√	√	√	√	√
23	* Moving parts and cables	• Lubricate.		√	√	√	√	√
24	* Throttle grip housing and cable	• Check operation and free play • Adjust the throttle cable free play if necessary. • Lubricate the throttle grip housing and cable.		√	√	√	√	√
25	* Lights, signals and switches	• Check operation. • Adjust headlight beam.	√	√	√	√	√	√

EAU18670

TIP

- The air filter needs more frequent service if you are riding in unusually wet or dusty areas.
- Hydraulic brake service
 - Regularly check and, if necessary, correct the brake fluid level.
 - Every two years replace the internal components of the brake master cylinders and calipers, and change the brake fluid.
 - Replace the brake hoses every four years and if cracked or damaged.

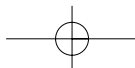

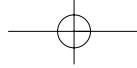

PERIODIC MAINTENANCE AND ADJUSTMENT

Removing and installing the cowlings and panel

EAU18731

The cowlings and panel shown need to be removed to perform some of the maintenance jobs described in this chapter. Refer to this section each time a cowling or panel needs to be removed and installed.

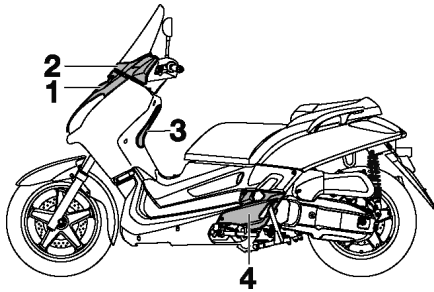

1. Cowling B
2. Cowling A
3. Panel A
4. Cowling C

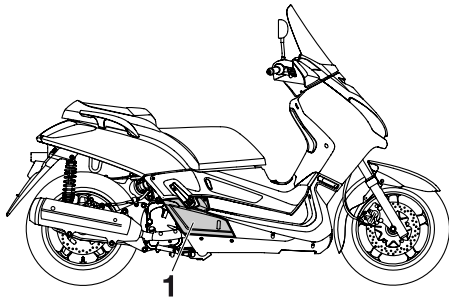

1. Cowling D

Cowling A

EAU18900

To remove the cowling

1. Remove the cowling bolts.

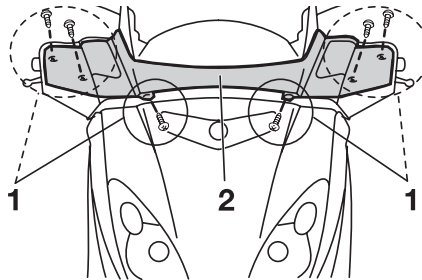

1. Bolt
2. Cowling A

2. Disconnect the turn signal light lead connectors, and then take the cowling off.

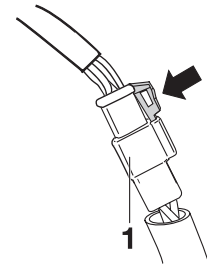

1. Turn signal light lead coupler

To install the cowling

1. Connect the turn signal light lead connectors.
2. Place the cowling in the original position.
3. Install the cowling bolts.

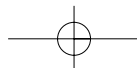

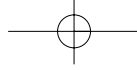

PERIODIC MAINTENANCE AND ADJUSTMENT

Cowling B

EAU18790

To remove the cowling

Remove the screws, and then take the cowling off.

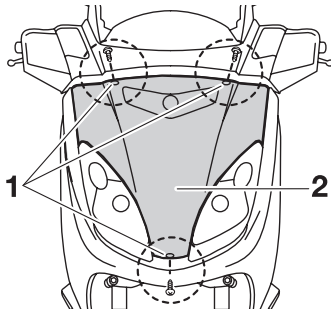

1. Bolt
2. Cowling B

To install the cowling

Place the cowling in the original position, and then install the screws.

Cowling C

EAU18790

To remove the cowling

Remove the screws, and then take the cowling off.

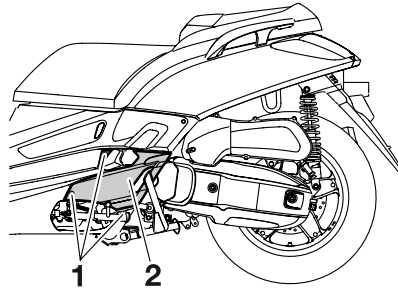

1. Bolt
2. Cowling C

To install the cowling

Place the cowling in the original position, and then install the screws.

Cowling D

EAU18790

To remove the cowling

Remove the screws, and then take the cowling off.

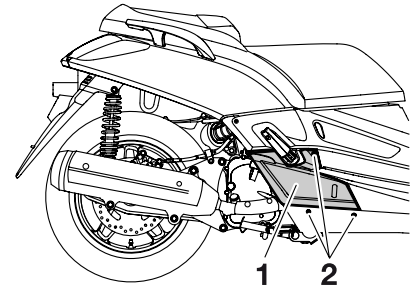

1. Cowling D
2. Bolt

To install the cowling

Place the cowling in the original position, and then install the screws.

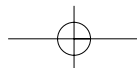

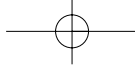

PERIODIC MAINTENANCE AND ADJUSTMENT

Panel A

EAM1250

EAU19632

To remove the panel

1. Open the storage compartment. (See page 3-16).
2. Remove the screw, and then take the panel off.

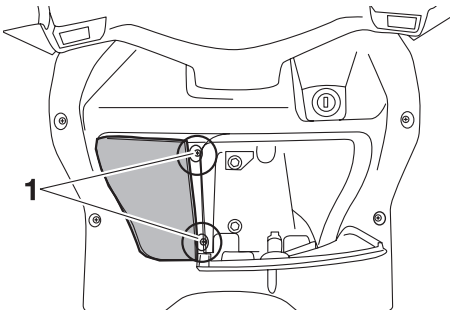

1. Screw

To install the panel

1. Place the panel in the original position, and then install the screw.
2. Close the storage compartment.

Checking the spark plug

The spark plug is an important engine component, which is easy to check. Since heat and deposits will cause any spark plug to slowly erode, the spark plug should be removed and checked in accordance with the periodic maintenance and lubrication chart. In addition, the condition of the spark plug can reveal the condition of the engine.

To remove the spark plug

1. Remove cowling D. (See page 6-6).
2. Remove the spark plug cap.

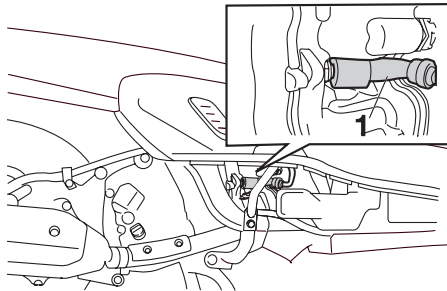

1. Spark plug cap

3. Remove the spark plug as shown, with the spark plug wrench included in the owner's tool kit.

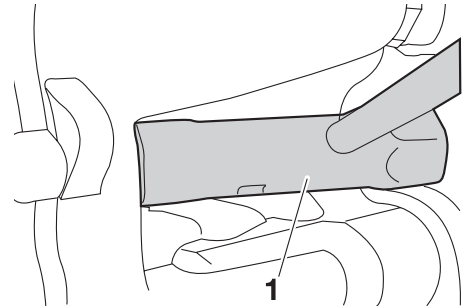

1. Spark plug wrench

To check the spark plug

1. Check that the porcelain insulator around the center electrode of the spark plug is a medium-to-light tan (the ideal color when the vehicle is ridden normally).

TIP

If the spark plug shows a distinctly different color, the engine could be operating improperly. Do not attempt to diagnose such problems yourself.



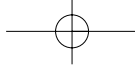

PERIODIC MAINTENANCE AND ADJUSTMENT

EAUM2271

Instead, have a Yamaha dealer check the vehicle.

2. Check the spark plug for electrode erosion and excessive carbon or other deposits, and replace it if necessary.

Specified spark plug:
NGK/ CPR 9EA-9

To install the spark plug

1. Measure the spark plug gap with a wire thickness gauge and, if necessary, adjust the gap to specification.

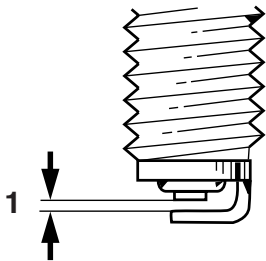

ZALM0037

1. Spark plug gap

Spark plug gap:
0.8–0.9 mm (0.031–0.035 in)

2. Clean the surface of the spark plug gasket and its mating surface, and then wipe off any grime from the spark plug threads.
3. Install the spark plug with the spark plug wrench, and then tighten it to the specified torque.

Tightening torque:

Spark plug:
17.5 Nm (1.75 m·kgf, 12.5 ft·lbf)

TIP

If a torque wrench is not available when installing a spark plug, a good estimate of the correct torque is 1/4–1/2 turn past finger tight. However, the spark plug should be tightened to the specified torque as soon as possible.

4. Install the spark plug cap.
5. Install the cowling.

Engine oil

The engine oil level should be checked before each ride. In addition, the oil must be changed at the intervals specified in the periodic maintenance and lubrication chart and when the service indicator light comes on.

To check the engine oil level

1. Place the scooter on the centers-stand. A slight tilt to the side can result in a false reading.
2. Start the engine, warm it up for several minutes, and then turn it off.
3. Wait a few minutes until the oil settles, remove the oil filler cap, wipe the dipstick clean, insert it back into the oil filler hole (without screwing it in), and then remove it again to check the oil level.

TIP

The engine oil should be between the minimum and maximum level marks.

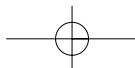

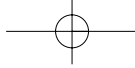

PERIODIC MAINTENANCE AND ADJUSTMENT

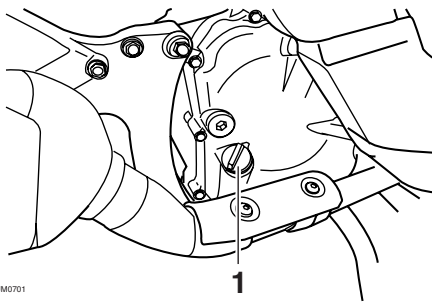

ZAJUM0701

1. Engine oil filler cap

4. If the engine oil is below the minimum level mark, add sufficient oil of the recommended type to raise it to the correct level.
5. Insert the dipstick into the oil filler hole, and then tighten the oil filler cap.

6

To change the engine oil (with or without oil filter element replacement)

1. Start the engine, warm it up for several minutes, and then turn it off.
2. Place an oil pan under the engine to collect the used oil.

3. Remove the engine oil filler cap and the engine oil drain bolt to drain the oil from the crankcase.

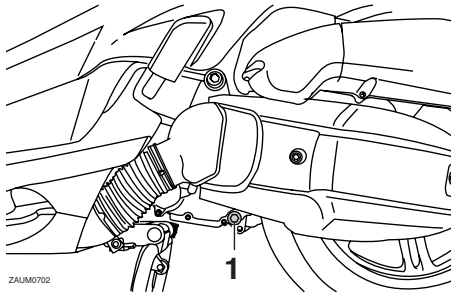

ZAJUM0702

1. Engine oil drain bolt

4. Check the drain bolt washer for damage and replace it if necessary.

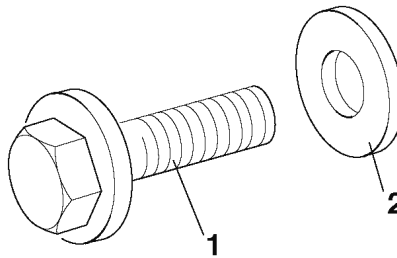

ZAJUM129

1. Engine oil drain bolt
2. Washer

TIP

Skip steps 5–9 if the oil filter element is not being replaced.

5. Remove the oil filter element cover by removing the bolts.

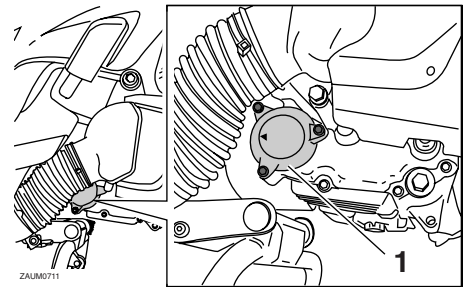

ZAJUM0711

1. Oil filter element cover

6. Remove the oil filter element and O-ring.

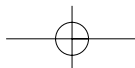

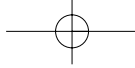

PERIODIC MAINTENANCE AND ADJUSTMENT

ECA11670

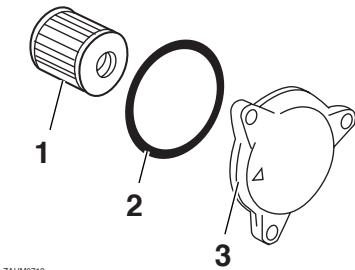

ZAUM0712

1. Oil filter element
2. O-ring
3. Oil filter element cover

7. Check the O-ring for damage and replace it if necessary.
8. Install the new oil filter element and an O-ring.
9. Install the oil filter element cover by installing the bolts, then tightening them to the specified torque.

Tightening torque:

Oil filter cover bolt:
10 Nm (1.0 m·kgf, 7.2 ft·lbf)

TIP

Make sure that the O-ring is properly seated.

10. Install the washer and the engine oil drain bolt, and then tighten the drain bolt to the specified torque.

Tightening torque:

Engine oil drain bolt:
20 Nm (2.0 m·kgf, 14 ft·lbf)

TIP

Make sure that the washer is properly seated.

11. Refill with the specified amount of the recommended engine oil, and then install and tighten the oil filler cap.

Recommended engine oil:

See page 8-1

Oil change quantity:

Without oil filter element replacement:
1.40 L (1.48 US qt, 1.23 Imp.qt)
With oil filter element replacement:
1.50 L (1.59 US qt, 1.32 Imp.qt)

TIP

Be sure to wipe off spilled oil on any parts after the engine and exhaust system have cooled down.

NOTICE

- Do not use oils with a diesel specification of “CD” or oils of a higher quality than specified. In addition, do not use oils labeled “ENERGY CONSERVING II” or higher.
- Be sure no foreign material enters the crankcase.

12. Start the engine, and then let it idle for several minutes while checking it for oil leakage. If oil is leaking, immediately turn the engine off and check for the cause.
13. Turn the engine off, and then check the oil level and correct it if necessary.
14. Reset the oil change indicator. (See page 3-6).

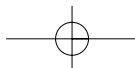

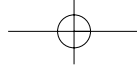

PERIODIC MAINTENANCE AND ADJUSTMENT

EAU20064

Final transmission oil

The final transmission case must be checked for oil leakage before each ride. If any leakage is found, have a Yamaha dealer check and repair the scooter. In addition, the final transmission oil must be changed as follows at the intervals specified in the periodic maintenance and lubrication chart.

1. Start the engine, warm up the final transmission oil by riding the scooter for several minutes, and then stop the engine.
2. Place the scooter on the centerstand.
3. Place an oil pan under the final transmission case to collect the used oil.
4. Remove the final transmission oil filler cap and final transmission drain bolt to drain the oil from the final transmission case.

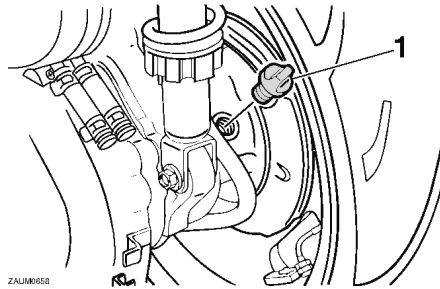

1. Final transmission oil filler cap

5. Install the final transmission oil drain bolt, and then tighten it to the specified torque.

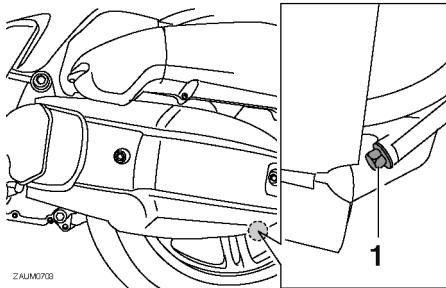

1. Final transmission oil drain bolt

Tightening torque:

Final transmission oil drain bolt:
20 Nm (2.0 m·kgf, 14 ft·lbf)

6-12

6. Refill with the specified amount of the recommended final transmission oil, and then install and tighten the oil filler cap. **WARNING! Make sure that no foreign material enters the final transmission case. Make sure that no oil gets on the tire or wheel.** [EWA11311]

Recommended final transmission oil:

See page 8-1

Oil quantity:

0.21 L (0.22 US qt, 0.18 Imp.qt)

7. Check the final transmission case for oil leakage. If oil is leaking, check for the cause.

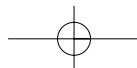

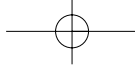

PERIODIC MAINTENANCE AND ADJUSTMENT

Coolant

The coolant level should be checked before each ride. In addition, the coolant must be changed at the intervals specified in the periodic maintenance and lubrication chart.

EAU20070

TIP

The coolant should be between the minimum and maximum level marks.

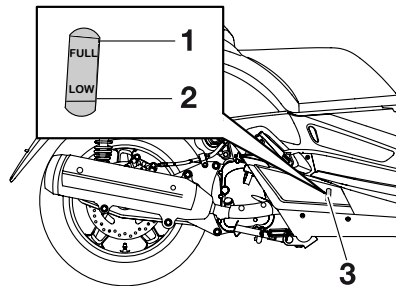

1. Maximum level mark
2. Minimum level mark
3. Coolant level check window

To check the coolant level

EAUS1274

1. Place the vehicle on a level surface and hold it in an upright position.

TIP

- The coolant level must be checked on a cold engine since the level varies with engine temperature.
 - Make sure that the vehicle is positioned straight up when checking the coolant level. A slight tilt to the side can result in a false reading.
2. Check the coolant level through the check window.

3. If the coolant is at or below the minimum level mark, remove the right floorboard mat by pulling it up.
4. Open the reservoir cap, and then add coolant to the maximum level mark. **WARNING! Remove only the coolant reservoir cap. Never attempt to remove the radiator cap when the engine is hot.** [EWA15161]. **NOTICE: If coolant is not available, use distilled water or soft tap water instead.**

6-13

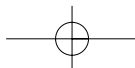

Do not use hard water or salt water since it is harmful to the engine. If water has been used instead of coolant, replace it with coolant as soon as possible, otherwise the cooling system will not be protected against frost and corrosion. If water has been added to the coolant, have a Yamaha dealer check the antifreeze content of the coolant as soon as possible, otherwise the effectiveness of the coolant will be reduced. [ECA10472]

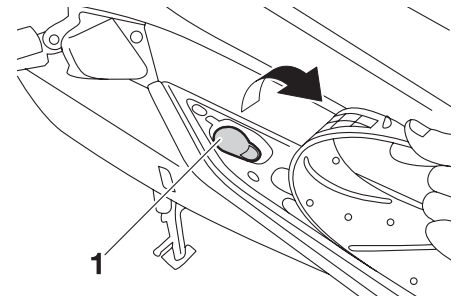

1. Coolant reservoir cap

Coolant reservoir capacity:
0.26 L (0.27 US qt, 0.23 Imp.qt)

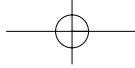

PERIODIC MAINTENANCE AND ADJUSTMENT

5. Close the reservoir cap
6. Place the floorboard mat in the original position and push it downward to secure it.

EAU33031

Changing the coolant

The coolant must be changed at the intervals specified in the periodic maintenance and lubrication chart. Have a Yamaha dealer change the coolant. **WARNING! Never attempt to remove the radiator cap when the engine is hot.** [EWA10381]

6

EAUM2242

Air filter and V-belt case air filter elements

The air filter element should be replaced and the V-belt case air filter element should be cleaned at the intervals specified in the periodic maintenance and lubrication chart. Service the air filter elements more frequently if you are riding in unusually wet or dusty areas.

2. Remove the air filter case cover by removing the screws.

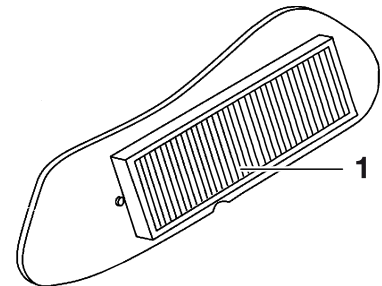

1. Air filter element

Replacing the air filter element

1. Place the scooter on the centerstand.

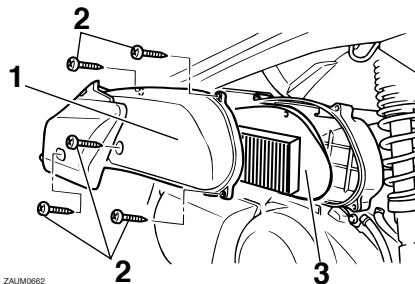

ZAJM0862

1. Air filter case cover
2. Screw
3. Air filter element

3. Pull the air filter element out.
4. Insert a new air filter element into the air filter case.
5. Install the air filter case cover by installing the screws.

Cleaning the V-belt case air filter element

1. Remove cowling C. (See page 6-6).
2. Remove the V-belt case air filter covers by removing the screws.

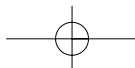

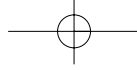

PERIODIC MAINTENANCE AND ADJUSTMENT

EAUS1290

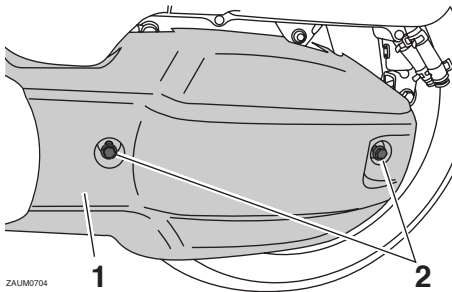

1. V-belt case air filter cover
2. Screw

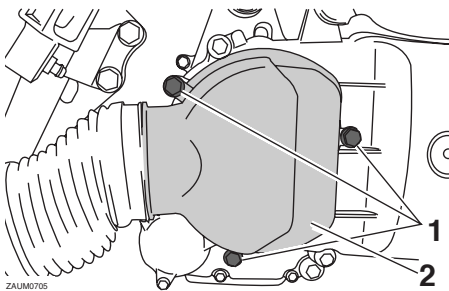

1. Screw
2. V-belt case air filter cover

3. Remove the air filter element, and then blow out the dirt with compressed air as shown.

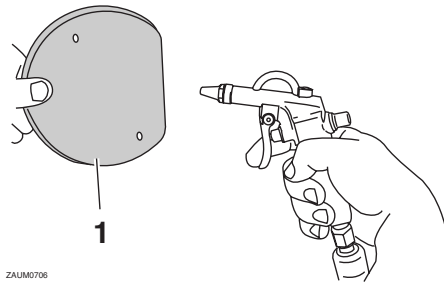

1. V-belt case air filter element

4. Check the air filter element for damage and replace it if necessary.

5. Install the air filter element with the colored side facing outward.

6. Install the V-belt case air filter covers by installing the screws.

NOTICE: Make sure that each filter element is properly seated in its case. The engine should never be operated without the filter elements installed, otherwise the piston(s) and/or cylinder(s) may become excessively worn. [ECA10531]

7. Install the cowling.

Adjusting the throttle cable free play

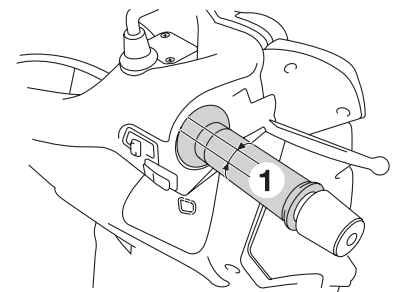

1. Throttle cable free play

The throttle cable free play should measure 3.0 -5.0 mm (0.12 -0.20 in) at the throttle grip. Periodically check the throttle cable free play and, if necessary, adjust it as follows.

TIP

The engine idling speed must be correctly adjusted before checking and adjusting the throttle cable free play.

1. Remove cowling A (See page 6-6).
2. Loosen the locknut.

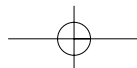

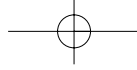

PERIODIC MAINTENANCE AND ADJUSTMENT

EAU21401

EAU21871

3. To increase the throttle cable free play, turn the adjusting nut in direction (a). To decrease the throttle cable free play, turn the adjusting nut in direction (b).

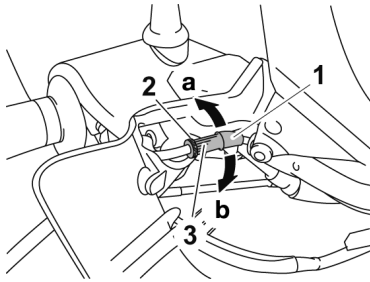

6

1. Rubber cap
2. Locknut
3. Adjusting nut

4. Tighten the locknut.
5. Install the cowling.

Valve clearance

The valve clearance changes with use, resulting in improper air-fuel mixture and/or engine noise. To prevent this from occurring, the valve clearance must be adjusted by a Yamaha dealer at the intervals specified in the periodic maintenance and lubrication chart.

Tires

To maximize the performance, durability, and safe operation of your vehicle, note the following points regarding the specified tires.

Tire air pressure

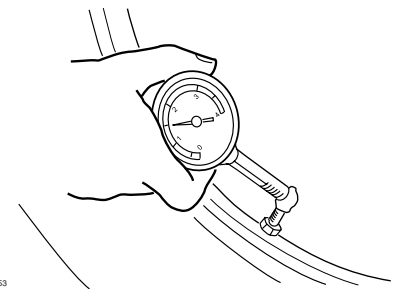

ZAU0053

The tire air pressure should be checked and, if necessary, adjusted before each ride.

EWA10500

WARNING

- The tire air pressure must be checked and adjusted on cold tires (i.e., when the temperature of the tires equals the ambient temperature).

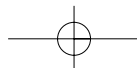

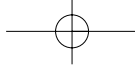

PERIODIC MAINTENANCE AND ADJUSTMENT

- The tire air pressure must be adjusted in accordance with the riding speed and with the total weight of rider, passenger, cargo, and accessories approved for this model.

Tire air pressure (measured on cold tires):

Up to 90 kg (198 lb):

Front:
190 kPa (27.02 psi) (1.9 kgf/cm²)

Rear:
220 kPa (31.29 psi) (2.2 kgf/cm²)

90 kg (198 lb) to maximum load:

Front:
210 kPa (29.86 psi) (2.1 kgf/cm²)

Rear:
250 kPa (35.55 psi) (2.5 kgf/cm²)

Maximum load*:

189 kg (417 lb)

* Total weight of rider, passenger, cargo and accessories

WARNING

Because loading has an enormous impact on the handling, braking, performance and safety characteristics of your vehicle, you should keep the following precautions in mind.

- **NEVER OVERLOAD THE VEHICLE!** Operation of an overloaded vehicle may result in tire damage, loss of control, or severe injury. Make sure that the total weight of rider, passenger, cargo, and accessories does not exceed the specified maximum load for the vehicle.
- Do not carry along loosely packed items, which can shift during a ride.
- Securely pack the heaviest items close to the center of the vehicle and distribute the weight evenly on both sides.
- Adjust the suspension and tire air pressure with regard to the load.
- Check the tire condition and air pressure before each ride.

EWA14660

Tire inspection

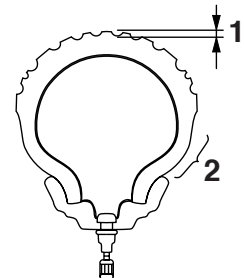

ZALUM0054

1. Tire tread depth
2. Tire sidewall

The tires must be checked before each ride. If the center tread depth reaches the specified limit, if the tire has a nail or glass fragments in it, or if the sidewall is cracked, have a Yamaha dealer replace the tire immediately.

Minimum tire tread depth (front and rear):
1.6 mm (0.06 in)



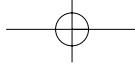

PERIODIC MAINTENANCE AND ADJUSTMENT

NOTE:

The tire tread depth limits may differ from country to country. Always comply with the local regulations.

Tire information

This vehicle is equipped with tubeless tires.

Front tire:

Size:

120/70-15 M/C 56S(Michelin - Continental)

120/70-15 M/C 56P(Pirelli)

Manufacturer/model:

Michelin/GoldStandard

Continental/ContiTwist TL

Pirelli/GTS23

Rear tire:

Size:

140/70-14 M/C 68S(Michelin - Continental)

140/70-14 M/C 68P(Pirelli)

Manufacturer/model:

Michelin/GoldStandard

Continental/ContiTwist TL

Pirelli/GTS24

WARNING

EWA10470

EAU21960

- **Have a Yamaha dealer replace excessively worn tires. Besides being illegal, operating the vehicle with excessively worn tires decreases riding stability and can lead to loss of control.**
- **The replacement of all wheel and brake related parts, including the tires, should be left to a Yamaha dealer, who has the necessary professional knowledge and experience.**

Cast wheels

To maximize the performance, durability, and safe operation of your vehicle, note the following points regarding the specified wheels.

- The wheel rims should be checked for cracks, bends or warpage before each ride. If any damage is found, have a Yamaha dealer replace the wheel. Do not attempt even the smallest repair to the wheel. A deformed or cracked wheel must be replaced.
- The wheel should be balanced whenever either the tire or wheel has been changed or replaced. An unbalanced wheel can result in poor performance, adverse handling characteristics, and a shortened tire life.
- Ride at moderate speeds after changing a tire since the tire surface must first be "broken in" for it to develop its optimal characteristics.



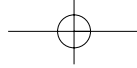

PERIODIC MAINTENANCE AND ADJUSTMENT

Front and rear brake lever free play

EAU33453

There should be no free play at the brake lever ends. If there is free play, have a Yamaha dealer inspect the brake system.

Front

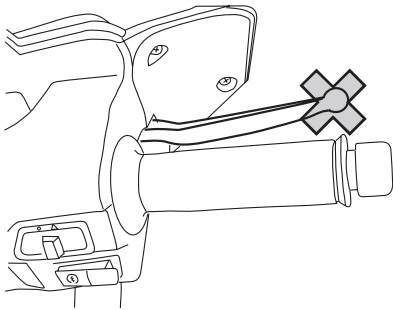

Rear

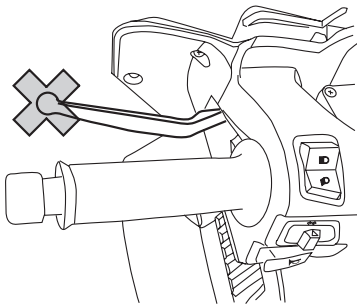

WARNING

EWA14211

A soft or spongy feeling in the brake lever can indicate the presence of air in the hydraulic system. If there is air in the hydraulic system, have a Yamaha dealer bleed the system before operating the vehicle. Air in the hydraulic system will diminish the braking performance, which may result in loss of control and an accident.

Checking the front and rear brake pads

EAU22390

The front and rear brake pads must be checked for wear at the intervals specified in the periodic maintenance and lubrication chart.

Front brake pads

EAU22400

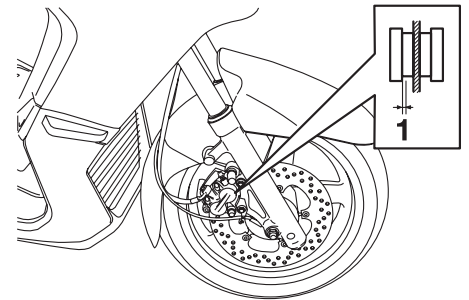

1. Lining thickness

Check each front brake pad for damage and measure the lining thickness. If a brake pad is damaged or if the lining thickness is less than 0.5 mm (0.02 in), have a Yamaha dealer replace the brake pads as a set.

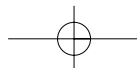

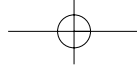

PERIODIC MAINTENANCE AND ADJUSTMENT

Rear brake pads

EAU22460

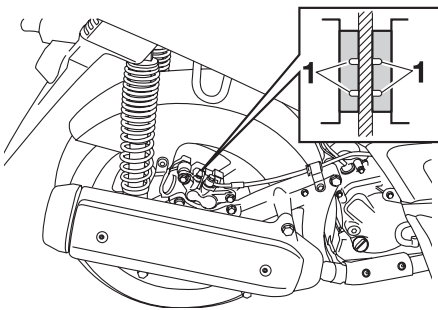

1. Brake pad wear indicator groove

The rear brake is provided with a check plug, which, if it is removed, allows you to check the brake pad wear without disassembling the brake. To check the brake pad wear, check the position of the wear indicator while applying the brake. If a brake pad has worn to the point that the wear indicator almost touches the brake disc, have a Yamaha dealer replace the brake pads as a set.

6

Checking the brake fluid level

EAU22580

Front brake

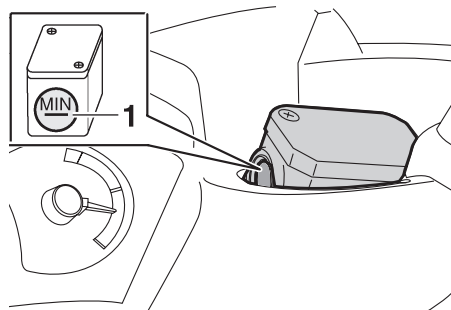

1. Minimum level mark

Rear brake

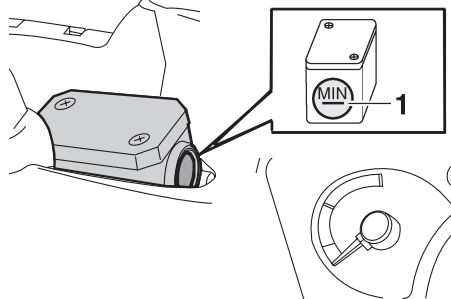

1. Minimum level mark

Insufficient brake fluid may allow air to enter the brake system, possibly causing it to become ineffective.

Before riding, check that the brake fluid is above the minimum level mark and replenish if necessary. A low brake fluid level may indicate worn brake pads and/or brake system leakage. If the brake fluid level is low, be sure to check the brake pads for wear and the brake system for leakage.

Observe these precautions:

- When checking the fluid level, make sure that the top of the brake fluid reservoir is level.
- Use only the recommended quality brake fluid, otherwise the rubber seals may deteriorate, causing leakage and poor braking performance.

Recommended brake fluid:
DOT 4

- Refill with the same type of brake fluid. Mixing fluids may result in a harmful chemical reaction and lead to poor braking performance.
- Be careful that water does not enter the brake fluid reservoir

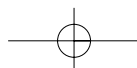

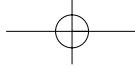

PERIODIC MAINTENANCE AND ADJUSTMENT

when refilling. Water will significantly lower the boiling point of the fluid and may result in vapor lock.

- Brake fluid may deteriorate painted surfaces or plastic parts. Always clean up spilled fluid immediately.
- As the brake pads wear, it is normal for the brake fluid level to gradually go down. However, if the brake fluid level goes down suddenly, have a Yamaha dealer check the cause.

EAU22721

Changing the brake fluid

Have a Yamaha dealer change the brake fluid at the intervals specified in the TIP after the periodic maintenance and lubrication chart. In addition, have the oil seals of the brake master cylinder and caliper as well as the brake hose replaced at the intervals listed below or whenever they are damaged or leaking.

- Oil seals: Replace every two years.
- Brake hose: Replace every four years.

EAU23101

Checking and lubricating the cables

The operation of all control cables and the condition of the cables should be checked before each ride, and the cables and cable ends should be lubricated if necessary. If a cable is damaged or does not move smoothly, have a Yamaha dealer check or replace it. **WARNING! Damage to the outer sheath may interfere with proper cable operation and will cause the inner cable to rust. Replace a damaged cable as soon as possible to prevent unsafe conditions.** [EWA10721]

<p>Recommended lubricant: Engine oil</p>

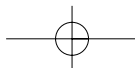

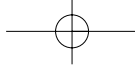

PERIODIC MAINTENANCE AND ADJUSTMENT

EAU23111

EAU23172

EAU23213

Checking and lubricating the throttle grip and cable

The operation of the throttle grip should be checked before each ride. In addition, the cable should be lubricated at the intervals specified in the periodic maintenance chart.

Lubricating the front and rear brake levers

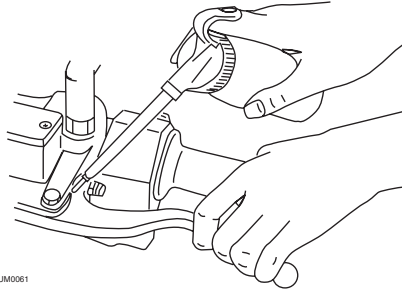

ZAUM0661

The pivoting points of the front and rear brake levers must be lubricated at the intervals specified in the periodic maintenance and lubrication chart.

Recommended lubricant:
Silicone grease

Checking and lubricating the centerstand and sidestand

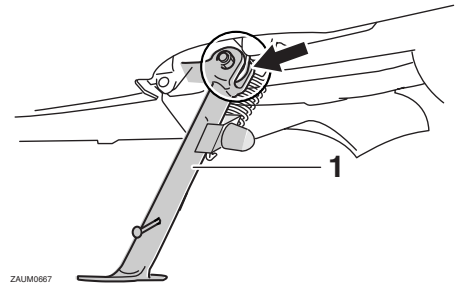

ZAUM0667

1. Sidestand

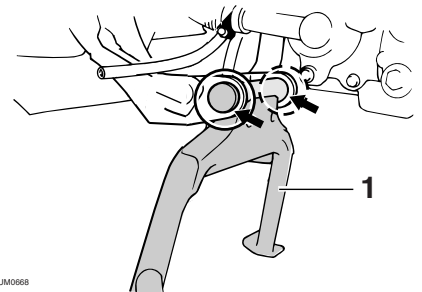

ZAUM0668

1. Centerstand

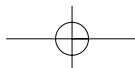

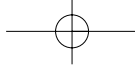

PERIODIC MAINTENANCE AND ADJUSTMENT

The operation of the centerstand and sidestand should be checked before each ride, and the pivots and metal-to-metal contact surfaces should be lubricated if necessary.

EWA10741

WARNING

If the centerstand or sidestand does not move up and down smoothly, have a Yamaha dealer check or repair it. Otherwise, the centerstand or sidestand could contact the ground and distract the operator, resulting in a possible loss of control.

Recommended lubricant:
Lithium-soap-based grease

Checking the front fork

EAU23272

The condition and operation of the front fork must be checked as follows at the intervals specified in the periodic maintenance and lubrication chart.

To check the condition

1. Check the inner tubes for scratches, damage and excessive oil leakage.

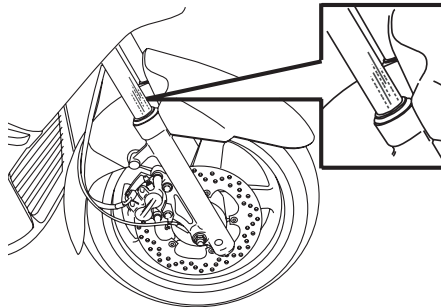

To check the operation

1. Place the vehicle on a level surface and hold it in an upright position. **WARNING! To avoid injury, securely support the vehicle so there is no danger of it falling over.** [EWA10751]

2. While applying the front brake, push down hard on the handlebars several times to check if the front fork compresses and rebounds smoothly.

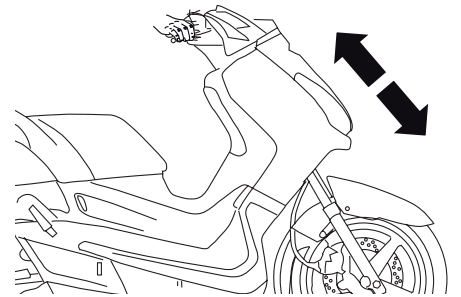

ECA10590

NOTICE

If any damage is found or the front fork does not operate smoothly, have a Yamaha dealer check or repair it.



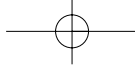

PERIODIC MAINTENANCE AND ADJUSTMENT

EAU45511

Checking the steering

Worn or loose steering bearings may cause danger. Therefore, the operation of the steering must be checked as follows at the intervals specified in the periodic maintenance and lubrication chart.

1. Place the vehicle on the centerstand. **WARNING! To avoid injury, securely support the vehicle so there is no danger of it falling over.** [EWA10751]
2. Hold the lower ends of the front fork legs and try to move them forward and backward. If any free play can be felt, have a Yamaha dealer check or repair the steering.

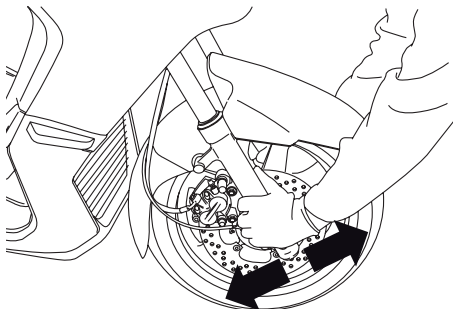

EAU23290

Checking the wheel bearings

The front and rear wheel bearings must be checked at the intervals specified in the periodic maintenance and lubrication chart. If there is play in the wheel hub or if the wheel does not turn smoothly, have a Yamaha dealer check the wheel bearings.

EAUT1404

Battery

This model is equipped with a VRLA (Valve Regulated Lead Acid) battery. There is no need to check the electrolyte or to add distilled water. However, the battery coupler connection needs to be checked to make sure that it is securely connected.

EWA10760

WARNING

- **Electrolyte is poisonous and dangerous since it contains sulfuric acid, which causes severe burns. Avoid any contact with skin, eyes or clothing and always shield your eyes when working near batteries. In case of contact, administer the following FIRST AID.**
 - **EXTERNAL:** Flush with plenty of water.
 - **INTERNAL:** Drink large quantities of water or milk and immediately call a physician.
 - **EYES:** Flush with water for 15 minutes and seek prompt medical attention.

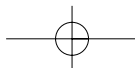

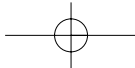

PERIODIC MAINTENANCE AND ADJUSTMENT

- Batteries produce explosive hydrogen gas. Therefore, keep sparks, flames, cigarettes, etc., away from the battery and provide sufficient ventilation when charging it in an enclosed space.
- KEEP THIS AND ALL BATTERIES OUT OF THE REACH OF CHILDREN.

To charge the battery

Have a Yamaha dealer charge the battery as soon as possible if it seems to have discharged. Keep in mind that the battery tends to discharge more quickly if the vehicle is equipped with optional electrical accessories.

NOTICE

ECA16520

To charge a VRLA (Valve Regulated Lead Acid) battery, a special (constant-voltage) battery charger is required. Using a conventional battery charger will damage the battery. If you do not have access to a constant-voltage battery charger,

have a Yamaha dealer charge your battery.

To store the battery

1. If the vehicle will not be used for more than one month, remove the battery, fully charge it, and then place it in a cool, dry place. **NOTICE:** When removing the battery, be sure the key is turned to "OFF" before disconnecting the couplers. [ECA16510]
2. If the battery will be stored for more than two months, check it at least once a month and fully charge it if necessary.

To remove the battery

1. Open the storage compartment. (See page 3-16)
2. Remove the panel by removing the screw.

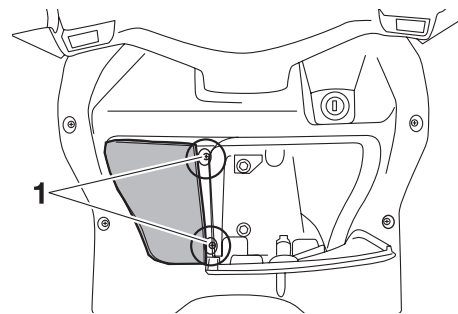

1. Screw

3. Remove the battery holder bracket by removing the bolt.

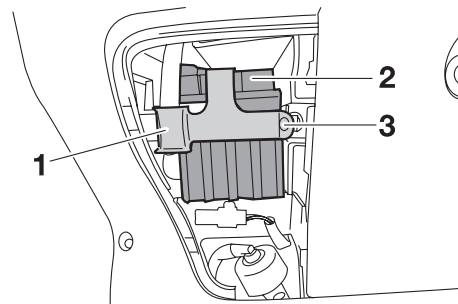

1. Holder
2. Battery
3. Bolt

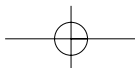

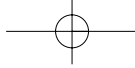

PERIODIC MAINTENANCE AND ADJUSTMENT

4. Pull the battery out from the battery box, and then disconnect the battery couplers.

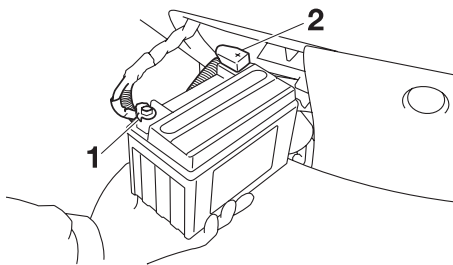

1. Negative battery lead
2. Positive battery lead (red)

6 To install the battery

1. Connect the battery couplers, and then place the battery in the original position.
2. Install the battery holder bracket by installing the bolt.
3. Install the panel by installing the screw.
4. Close the storage compartment.
5. Fully charge the battery before installation.

NOTICE

Always keep the battery charged. Storing a discharged battery can cause permanent battery damage.

ECA16530

EAU23526

Replacing the fuses

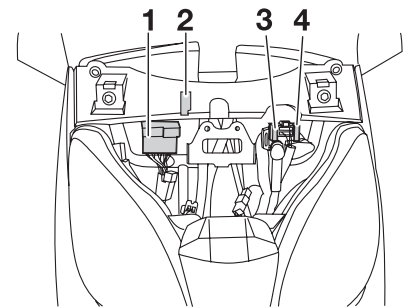

1. Fuse box
2. Fuse tong
3. Main fuse
4. Spare main fuse

The main fuse and the fuse box, which contains the fuses for the individual circuits, are located behind panel B. (See page 6-6).

If a fuse is blown, replace it as follows.

1. Turn the key to "OFF" and turn off the electrical circuit in question.
2. Remove the blown fuse, and then install a new fuse of the specified amperage. **WARNING! Do not use a fuse of a higher amperage rating than recommended**

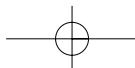

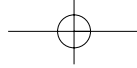

PERIODIC MAINTENANCE AND ADJUSTMENT

to avoid causing extensive damage to the electrical system and possibly a fire. [EWA15131]

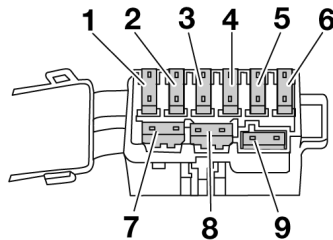
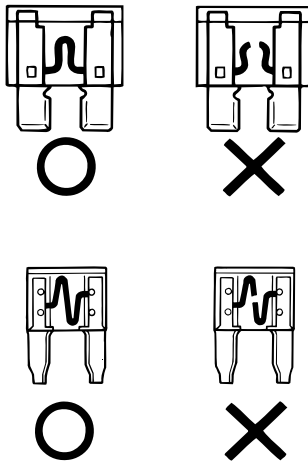

1. Signaling system fuse
2. Hazard fuse
3. Radiator fan fuse
4. ECU (Electronic Control Unit) fuse
5. Ignition fuse
6. Backup fuse
7. Spare fuse
8. Spare fuse
9. Spare fuse

Specified fuses:

Main fuse:
30.0 A
ECU (Electronic Control Unit) fuse:
5.0 A
Signaling system fuse:
15.0 A
Ignition fuse:
5.0 A
Headlight fuse:
15.0 A
Backup fuse:
5.0 A
Radiator fan fuse:
10.0 A

3. Turn the key to "ON" and turn on the electrical circuit in question to check if the device operates.
4. If the fuse immediately blows again, have a Yamaha dealer check the electrical system.

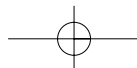

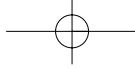

PERIODIC MAINTENANCE AND ADJUSTMENT

Replacing a headlight bulb

EAU23911

This model is equipped with quartz bulb headlights. If a headlight bulb burns out, replace it as follows.

NOTICE

ECA10660

Do not touch the glass part of the headlight bulb to keep it free from oil, otherwise the transparency of the glass, the luminosity of the bulb, and the bulb life will be adversely affected. Thoroughly clean off any dirt and fingerprints on the headlight bulb using a cloth moistened with alcohol or thinner.

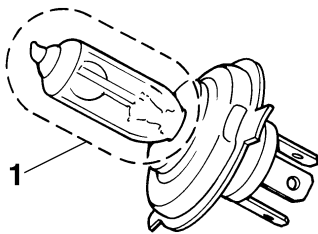

1. Do not touch the glass part of the bulb.

1. Remove cowling B. (See page 6-6).
2. Disconnect the headlight coupler, and then remove the headlight bulb cover.

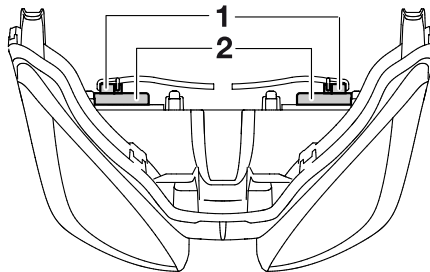

1. Headlight coupler
2. Headlight bulb cover

3. Remove the headlight bulb holder according to the following illustration, and then remove the burnt out bulb.

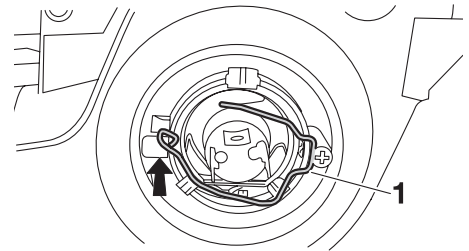

1. Headlight bulb holder

TIP

The removal procedure depends on the type of bulb holder installed on your vehicle.

4. Place a new bulb into position, and then secure it with the bulb holder.
5. Install the bulb cover, and then connect the coupler.
6. Install the cowling.
7. Have a Yamaha dealer adjust the headlight beam if necessary.

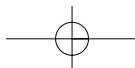

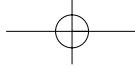

PERIODIC MAINTENANCE AND ADJUSTMENT

Replacing a front turn signal light bulb

EAUT1261

ECA10670

NOTICE

It is advisable to have a Yamaha dealer perform this job.

1. Place the scooter on the centers-stand.
2. Remove cowling A. (See page 6-6).
3. Remove the socket (together with the bulb) by turning it counterclockwise.

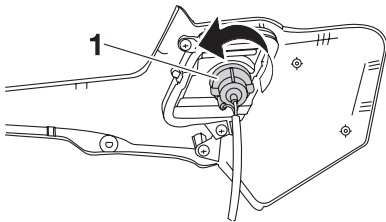

1. Turn signal light bulb socket
4. Remove the burnt out bulb by pushing it in and turning it counterclockwise.

5. Insert a new bulb into the socket, push it in, and then turn it clockwise until it stops.
6. Install the socket (together with the bulb) by turning it clockwise.
7. Install the cowling.

Replacing a tail/brake light bulb or a rear turn signal light bulb

EAUS1442

1. Place the scooter on the centers-stand.
2. Open the seat, and then remove the rear storage compartment. (See page 3-17).

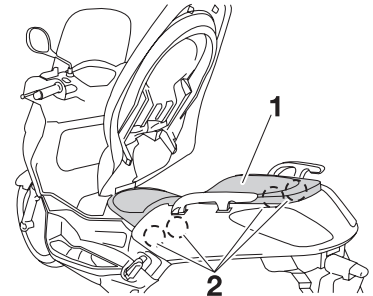

1. Rear storage compartment
2. Bolt

3. Remove the tail/brake light and turn signal light bulb holder by pulling it outward.

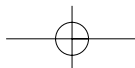

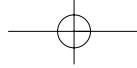

PERIODIC MAINTENANCE AND ADJUSTMENT

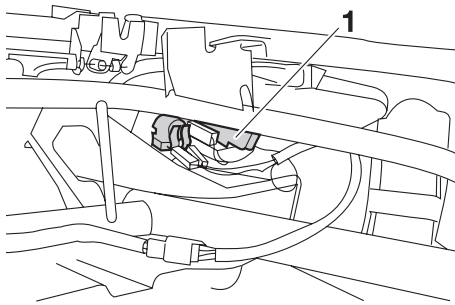

1. Turn signal light bulb socket/ Tail/brake light bulb socket

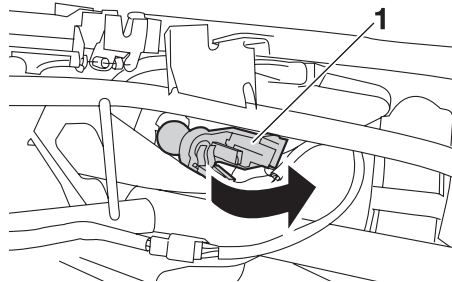

1. Remove.

4. Remove the burnt-out bulb by pushing it in and turning it counterclockwise.

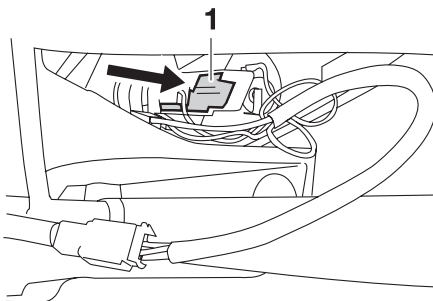

1. Unlock.

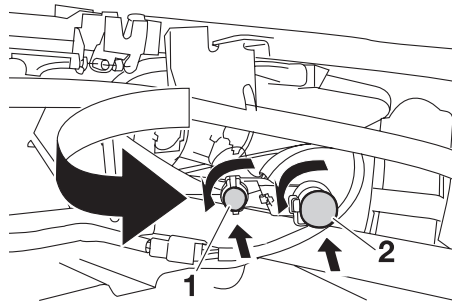

1. Turn signal light bulb
2. Tail/brake light bulb

5. Insert a new bulb into the socket by pushing it in and turning it clockwise.
6. Install the bulb holder by pushing it into the original position.
7. Install the rear storage compartment, and then close the seat.

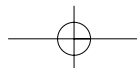

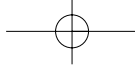

PERIODIC MAINTENANCE AND ADJUSTMENT

Replacing the license plate light bulb

EAUM2201

1. Remove the socket (together with the bulb) by pulling it out.

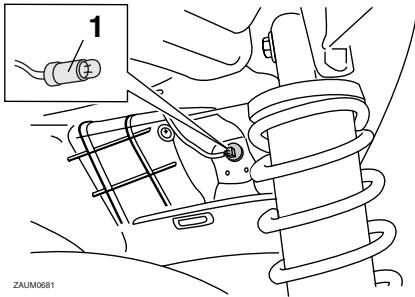

1. License plate light bulb socket

2. Remove the burnt out bulb by pulling it out.

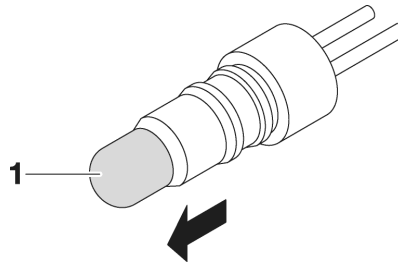

1. License plate light bulb

3. Insert a new bulb into the socket.
4. Install the socket (together with the bulb) by pushing it in.

Replacing an auxiliary light bulb

EAUM2212

This model is equipped with two auxiliary lights. If an auxiliary light bulb burns out, replace it as follows.

1. Remove cowling B. (See page 6-6).
2. Remove the socket (together with the bulb) by pulling it out.

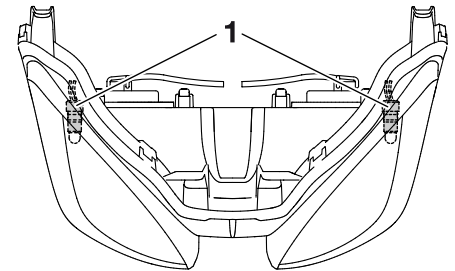

1. Auxiliary light bulb socket

3. Remove the burnt out bulb by pulling it out.

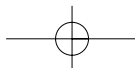

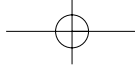

PERIODIC MAINTENANCE AND ADJUSTMENT

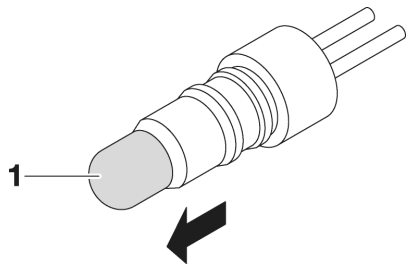

1. Auxiliary light bulb

4. Insert a new bulb into the socket.
5. Install the socket (together with the bulb) by pushing it in.
6. Install the cowling.

6

Troubleshooting

Although Yamaha scooters receive a thorough inspection before shipment from the factory, trouble may occur during operation. Any problem in the fuel, compression, or ignition systems, for example, can cause poor starting and loss of power.

The following troubleshooting charts represent quick and easy procedures for checking these vital systems yourself. However, should your scooter require any repair, take it to a Yamaha dealer, whose skilled technicians have the necessary tools, experience, and know-how to service the scooter properly.

Use only genuine Yamaha replacement parts. Imitation parts may look like Yamaha parts, but they are often inferior, have a shorter service life and can lead to expensive repair bills.

EAU25881

EWA15141

WARNING

When checking the fuel system, do not smoke, and make sure there are no open flames or sparks in the area, including pilot lights from water heaters or furnaces. Gasoline or gasoline vapors can ignite or explode, causing severe injury or property damage.

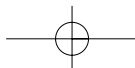

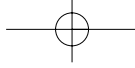

PERIODIC MAINTENANCE AND ADJUSTMENT

EAU42131

Troubleshooting charts Starting problems or poor engine performance

1. Fuel

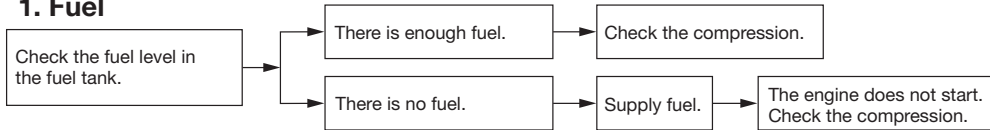

2. Compression

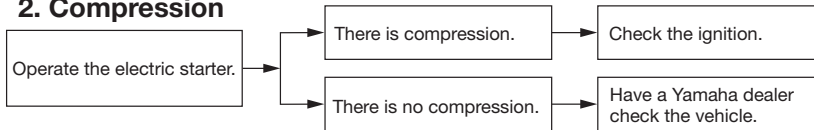

3. Ignition

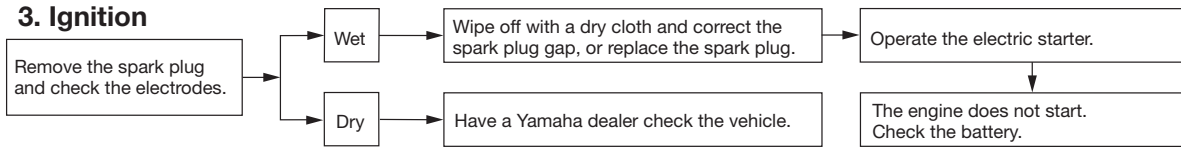

4. Battery

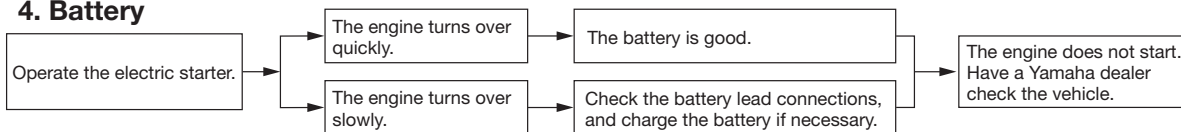

6

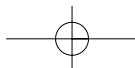

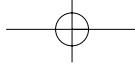

PERIODIC MAINTENANCE AND ADJUSTMENT

Engine overheating

EWA10400

⚠ WARNING

- Do not remove the radiator cap when the engine and radiator are hot. Scalding hot fluid and steam may be blown out under pressure, which could cause serious injury. Be sure to wait until the engine has cooled.
- After removing the radiator cap retaining bolt, place a thick rag, like a towel, over the radiator cap, and then slowly rotate the cap counterclockwise to the detent to allow any residual pressure to escape. When the hissing sound has stopped, press down on the cap while turning it counterclockwise, and then remove the cap.

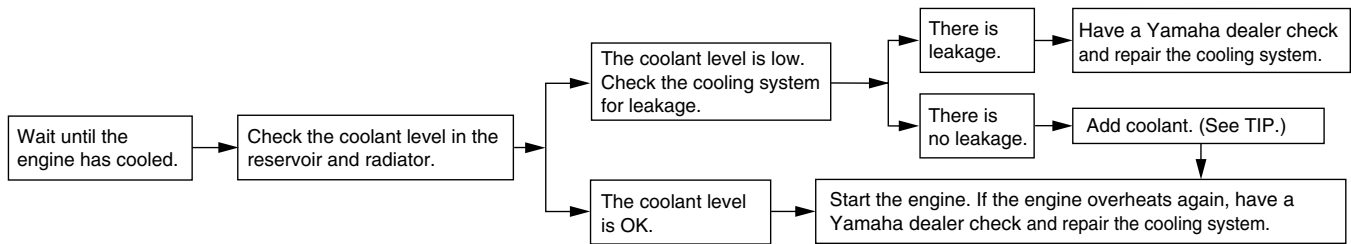

TIP

If coolant is not available, tap water can be temporarily used instead, provided that it is changed to the recommended coolant as soon as possible.



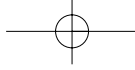

SCOOTER CARE AND STORAGE

Matte color caution

EAU37833

EAU26093

NOTICE

ECA15192

Some models are equipped with matte colored finished parts. Be sure to consult a Yamaha dealer for advice on what products to use before cleaning the vehicle. Using a brush, harsh chemical products or cleaning compounds when cleaning these parts will scratch or damage their surface. Wax also should not be applied to any matte colored finished parts.

Care

While the open design of a scooter reveals the attractiveness of the technology, it also makes it more vulnerable. Rust and corrosion can develop even if high-quality components are used. A rusty exhaust pipe may go unnoticed on a car, however, it detracts from the overall appearance of a scooter. Frequent and proper care does not only comply with the terms of the warranty, but it will also keep your scooter looking good, extend its life and optimize its performance.

Before cleaning

1. Cover the muffler outlet with a plastic bag after the engine has cooled down.
2. Make sure that all caps and covers as well as all electrical couplers and connectors, including the spark plug cap, are tightly installed.
3. Remove extremely stubborn dirt, like oil burnt onto the crankcase, with a degreasing agent and a

brush, but never apply such products onto seals, gaskets and wheel axles. Always rinse the dirt and degreaser off with water.

Cleaning

ECA10782

NOTICE

- **Avoid using strong acidic wheel cleaners, especially on spoked wheels. If such products are used on hard-to-remove dirt, do not leave the cleaner on the affected area any longer than instructed. Also, thoroughly rinse the area off with water, immediately dry it, and then apply a corrosion protection spray.**
- **Improper cleaning can damage plastic parts (such as cowlings, panels, windshields, headlight lenses, meter lenses, etc.) and the mufflers. Use only a soft, clean cloth or sponge with water to clean plastic. However, if the plastic parts cannot be thoroughly cleaned with water, diluted mild detergent**

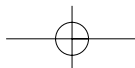

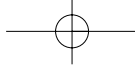

SCOOTER CARE AND STORAGE

with water may be used. Be sure to rinse off any detergent residue using plenty of water, as it is harmful to plastic parts.

- Do not use any harsh chemical products on plastic parts. Be sure to avoid using cloths or sponges which have been in contact with strong or abrasive cleaning products, solvent or thinner, fuel (gasoline), rust removers or inhibitors, brake fluid, antifreeze or electrolyte.
- Do not use high-pressure washers or steam-jet cleaners since they cause water seepage and deterioration in the following areas: seals (of wheel and swingarm bearings, fork and brakes), electric components (couplers, connectors, instruments, switches and lights), breather hoses and vents.
- For scooters equipped with a windshield: Do not use strong cleaners or hard sponges as they will cause dulling or scratching. Some cleaning compounds for plastic may leave

scratches on the windshield. Test the product on a small hidden part of the windshield to make sure that it does not leave any marks. If the windshield is scratched, use a quality plastic polishing compound after washing.

After normal use

Remove dirt with warm water, a mild detergent, and a soft, clean sponge, and then rinse thoroughly with clean water. Use a toothbrush or bottle-brush for hard-to-reach areas. Stubborn dirt and insects will come off more easily if the area is covered with a wet cloth for a few minutes before cleaning.

After riding in the rain, near the sea or on salt-sprayed roads

Since sea salt or salt sprayed on the roads during winter are extremely corrosive in combination with water, carry out the following steps after each ride in the rain, near the sea or on salt-sprayed roads.

TIP

Salt sprayed on roads in the winter may remain well into spring.

1. Clean the scooter with cold water and a mild detergent after the engine has cooled down. **WARNING! Do not use warm water since it increases the corrosive action of the salt.** [ECA10791]
2. Apply a corrosion protection spray on all metal, including chrome- and nickel-plated, surfaces to prevent corrosion.

After cleaning

1. Dry the scooter with a chamois or an absorbing cloth.
2. Use a chrome polish to shine chrome, aluminum and stainless-steel parts, including the exhaust system. (Even the thermally induced discoloring of stainless-steel exhaust systems can be removed through polishing.)
3. To prevent corrosion, it is recommended to apply a corrosion protection spray on all metal, including chrome- and nickel-plated, surfaces.



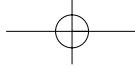

SCOOTER CARE AND STORAGE

4. Use spray oil as a universal cleaner to remove any remaining dirt.
5. Touch up minor paint damage caused by stones, etc.
6. Wax all painted surfaces.
7. Let the scooter dry completely before storing or covering it.

EWA10941

WARNING

Contaminants on the brakes or tires can cause loss of control.

- Make sure that there is no oil or wax on the brakes or tires. If necessary, clean the brake discs and brake linings with a regular brake disc cleaner or acetone, and wash the tires with warm water and a mild detergent.
- Before operating the scooter test its braking performance and cornering behavior.

NOTICE

- Apply spray oil and wax sparingly and make sure to wipe off any excess.
- Never apply oil or wax to any rubber and plastic parts, but treat them with a suitable care product.
- Avoid using abrasive polishing compounds as they will wear away the paint.

TIP

- Consult a Yamaha dealer for advice on what products to use.
- Washing, rainy weather or humid climates can cause the headlight lens to fog. Turning the headlight on for a short period of time will help remove the moisture from the lens.

ECA10800

Storage

Short-term

Always store your scooter in a cool, dry place and, if necessary, protect it against dust with a porous cover.

EAU36561

ECA10820

NOTICE

- Storing the scooter in a poorly ventilated room or covering it with a tarp, while it is still wet, will allow water and humidity to seep in and cause rust.
- To prevent corrosion, avoid damp cellars, stables (because of the presence of ammonia) and areas where strong chemicals are stored.

Long-term

Before storing your scooter for several months:

1. Follow all the instructions in the "Care" section of this chapter.
2. Fill up the fuel tank and add fuel stabilizer (if available) to prevent the fuel tank from rusting and the fuel from deteriorating.

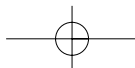

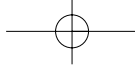

SCOOTER CARE AND STORAGE

3. Perform the following steps to protect the cylinder, piston rings, etc. from corrosion.
 - a. Remove the spark plug cap and spark plug.
 - b. Pour a teaspoonful of engine oil into the spark plug bore.
 - c. Install the spark plug cap onto the spark plug, and then place the spark plug on the cylinder head so that the electrodes are grounded. (This will limit sparking during the next step.)
 - d. Turn the engine over several times with the starter. (This will coat the cylinder wall with oil.)
 - e. Remove the spark plug cap from the spark plug, and then install the spark plug and the spark plug cap. **WARNING! To prevent damage or injury from sparking, make sure to ground the spark plug electrodes while turning the engine over.** [EWA10951]
4. Lubricate all control cables and the pivoting points of all levers and pedals as well as of the sidestand/centerstand.
5. Check and, if necessary, correct the tire air pressure, and then lift the scooter so that both of its wheels are off the ground. Alternatively, turn the wheels a little every month in order to prevent the tires from becoming degraded in one spot.
6. Cover the muffler outlet with a plastic bag to prevent moisture from entering it.
7. Remove the battery and fully charge it. Store it in a cool, dry place and charge it once a month. Do not store the battery in an excessively cold or warm place [less than 0 °C (30 °F) or more than 30 °C (90 °F)]. For more information on storing the battery, see page 6-24.

TIP _____
Make any necessary repairs before storing the scooter.

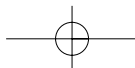

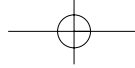

SPECIFICATIONS

Dimensions:

- Overall length:
2210 mm (87.0 in)
- Overall width:
790 mm (31.1 in)
- Overall height:
1380 mm (54.3 in)
- Seat height:
785 mm (30.9 in)
- Wheelbase:
1545 mm (60.8 in)
- Ground clearance:
112 mm (4.44 in)
- Minimum turning radius:
3650 mm (143.7 in)

Weight:

- With oil and fuel:
166 kg (366 lb)

Engine:

- Engine type:
Liquid cooled 4-stroke, SOHC
- Cylinder arrangement:
Forward-inclined single cylinder
- Displacement:
124.6 cm³
- Bore x stroke:
52.0 x 58.6 mm (2.05 x 2.31 in)
- Compression ratio:
11.20 :1
- Starting system:
Electric starter
- Lubrication system:
Wet sump

Engine oil:

- Type:
SAE 10W-30, SAE 10W-40, SAE 15W-40,
SAE 20W-40 or SAE 20W-50

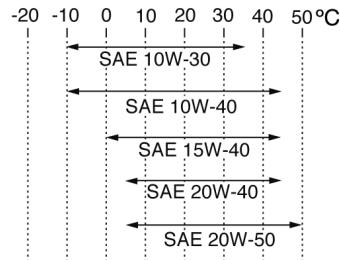

- Recommended engine oil grade:
API service SG type or higher, JASO standard MA

- Engine oil quantity:
Without oil filter cartridge replacement:
1.40 L (1.48 US qt) (1.23 Imp.qt)
- With oil filter element replacement:
1.50 L (1.59 US qt) (1.32 Imp.qt)

Final transmission oil:

- Type:
SAE 10W-30 type SE motor oil
- Quantity:
0.21 L (0.22 US qt) (0.18 Imp.qt)

Cooling system:

- Coolant reservoir capacity (up to the maximum level mark):
0.26 L (0.27 US qt) (0.23 Imp.qt)
- Radiator capacity (including all routes):
1.40 L (1.48 US qt) (1.23 Imp.qt)

Air filter:

- Air filter element:
Oil-coated paper element

Fuel:

- Recommended fuel:
Regular unleaded gasoline only
- Fuel tank capacity:
12.5 L (3.30 US gal) (2.75 Imp.gal)
- Fuel reserve amount:
2 L (0.53 US gal) (0.44 Imp.gal)

Throttle body:

- Type/quantity:
EFI (1B9) / 1
- Manufacturer:
AISAN

Spark plug (s):

- Manufacturer/model:
NGK/ CPR 9EA-9
- Spark plug gap:
0.8-0.9 mm (0.031-0.035 in)

Clutch:

- Clutch type:
Dry, centrifugal automatic

Transmission:

- Primary reduction system:
Helical gear
- Primary reduction ratio:
41/14 (2.929)
- Secondary reduction system:
Helical gear
- Secondary reduction ratio:
44/13 (3.384)
- Transmission type:
V-belt automatic

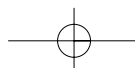

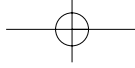

SPECIFICATIONS

Chassis:

Frame type:
Steel tube underbone
Caster angle:
28.00 degree
Trail:
100.0 mm (3.94 in)

Front tire:

Type:
Tubeless
Size:
120/70-15 M/C 56S(Michelin -
Continental)
120/70-15 M/C 56P(Pirelli)
Manufacturer/model:
Michelin/GoldStandard
Manufacturer/model:
Continental/ContiTwist TL
Manufacturer/model:
Pirelli/GTS23

Rear tire:

Type:
Tubeless
Size:
140/70-14 M/C 68S(Michelin -
Continental)
140/70-14 M/C 68P(Pirelli)
Manufacturer/model:
Michelin/GoldStandard
Manufacturer/model:
Continental/ContiTwist TL
Manufacturer/model:
Pirelli/GTS24

Loading:

Maximum load:
189 kg (417 lb)
(Total weight of rider, passenger, cargo
and accessories)

Tire air pressure (measured on cold tires):

Loading condition:
0-90 kg
Front:
190 kPa (28 psi) (1.90 kgf/cm²) (1.90 bar)
Rear:
220 kPa (32 psi) (2.20 kgf/cm²) (2.20 bar)
Loading condition:
90 kg - maximum load
Front:
210 kPa (30 psi) (2.10 kgf/cm²) (2.10 bar)
Rear:
250 kPa (36 psi) (2.50 kgf/cm²) (2.50 bar)
High-speed riding:
Front:
210 kPa (30 psi) (2.10 kgf/cm²) (2.10 bar)
Rear:
250 kPa (36 psi) (2.50 kgf/cm²) (2.50 bar)

Front wheel:

Wheel type:
Cast wheel
Rim size:
15 x MT3.5

Rear wheel:

Wheel type:
Cast wheel
Rim size:
14 x MT3.75

Front brake:

Type:
Single disc brake
Operation:
Right hand operation
Recommended fluid:
DOT 4

Rear brake:

Type:
Single disc brake
Operation:
Left hand operation
Recommended fluid:
DOT 4

Front suspension:

Type:
Telescopic fork
Spring/shock absorber type:
Coil spring/oil damper
Wheel travel:
94.0 mm (3.70 in)

Rear suspension:

Spring/shock absorber type:
Coil spring/oil damper
Wheel travel:
83.0 mm (3.27 in)

Electrical system:

Ignition system:
Transistorized coil ignition (digital)
Charging system:
AC magneto

Battery:

Model:
YTX9-BS

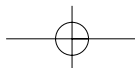

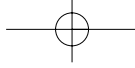

SPECIFICATIONS

Voltage, capacity: 12 V, 8.0 Ah	Signaling system fuse: 15.0 A
Headlight:	Ignition fuse: 10.0 A
Bulb type: Halogen bulb	Radiator fan fuse: 10.0 A
Bulb voltage, wattage x quantity:	ECU (Electronic Control Unit) fuse: 5.0 A
Headlight: 12 V, 35 W/35.0 W x 2	Backup fuse: 5.0 A
Tail/brake light: 12 V, 21.0 W/5.0 W x 2	
Front turn signal light: 12 V, 10.0 W x 2	
Rear turn signal light: 12 V, 10.0 W x 2	
Auxiliary light: 12 V, 5.0 W x 2	
License plate light: 12 V, 5.0 W x 1	
Meter lighting: LED	
High beam indicator light: LED x 1	
Turn signal indicator light: LED x 2	
Engine trouble warning light: LED x 1	
Immobilizer system indicator light: LED x 1	
Fuses:	
Main fuse: 30.0 A	
Headlight fuse: 15.0 A	

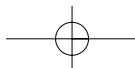

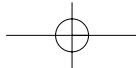

CONSUMER INFORMATION

EAU26351

EAU26381

EAU26410

Identification numbers

Record the key identification number, vehicle identification number and model label information in the spaces provided below for assistance when ordering spare parts from a Yamaha dealer or for reference in case the vehicle is stolen.

● KEY IDENTIFICATION NUMBER:

● VEHICLE IDENTIFICATION NUMBER:

● MODEL LABEL INFORMATION:

Key identification number

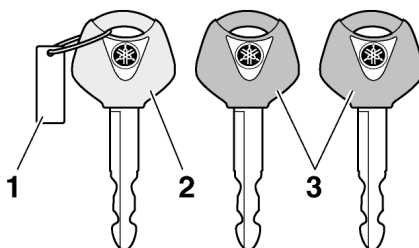

- 1. Key identification number
- 2. Code re-registering key (red bow)
- 3. Standard keys (black bow)

The key identification number is stamped into the key tag. Record this number in the space provided and use it for reference when ordering a new key.

Vehicle identification number

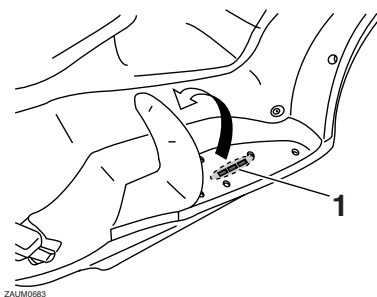

- 1. Vehicle identification number

The vehicle identification number is stamped into the frame.

TIP The vehicle identification number is used to identify your vehicle and may be used to register it with the licensing authority in your area.

9

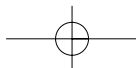

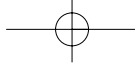

CONSUMER INFORMATION

EAU26490

Model label

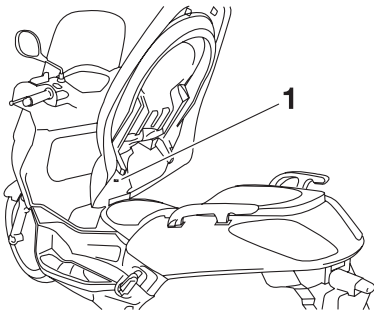

1. Model label

The model label is affixed to the bottom of the seat. (See page 3-14). Record the information on this label in the space provided. This information will be needed when ordering spare parts from a Yamaha dealer.

9-2

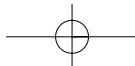

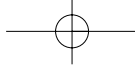

INDEX

- A**
- Acceleration and deceleration5-3
 - Air filter and V-belt case air filter elements6-14
 - Anti-theft alarm (optional)3-9
 - Auxiliary light bulb, replacing6-31
- B**
- Battery6-24
 - Brake fluid level, checking6-20
 - Brake fluid, changing6-21
 - Brake lever, front3-10
 - Brake lever, rear3-10
 - Brake levers, lubricating6-22
 - Braking5-3
- C**
- Cables, checking and lubricating6-21
 - Care7-1
 - Catalytic converters3-13
 - Centerstand and sidestand, checking and lubricating6-22
 - Coolant6-13
 - Coolant temperature gauge3-5
 - Cowlings and panel, removing and installing6-6
- D**
- Dimmer switch3-9
 - Display, multi-function3-6
- E**
- Engine break-in5-4
 - Engine oil6-9
 - Engine trouble warning light3-4
- F**
- Final transmission oil6-12
 - Front and rear brake lever free play6-19
 - Front and rear brake pads, checking6-19
 - Front fork, checking6-23
 - Front storage compartment3-16
 - Fuel3-12
 - Fuel consumption, tips for reducing5-4
 - Fuel gauge3-5
 - Fuel level warning light3-4
 - Fuel tank cap3-11
 - Fuses, replacing6-26
- H**
- Handlebar switches3-9
 - Hazard switch3-10
 - Headlight bulb, replacing6-28
 - High beam indicator light3-3
 - Horn switch3-9
- I**
- Identification numbers9-1
 - Ignition circuit cut-off system3-19
 - Immobilizer system3-1
 - Immobilizer system indicator light3-4
 - Indicator and warning lights3-3
- K**
- Key identification number9-1
- L**
- License plate light bulb, replacing6-31
- M**
- Main switch/steering lock3-2
 - Maintenance and lubrication, periodic6-3
 - Maintenance, emission control system6-2
 - Matte color, caution7-1
 - Model label9-2
- P**
- Parking5-5
 - Part locations2-1
 - Periodic maintenance and lubrication chart6-2
- R**
- Rear storage compartment3-17
- S**
- Safe-riding points1-5
 - Safety information1-1
 - Seat3-14
 - Securing bracket3-14
 - Shock absorber assemblies, adjusting3-18
 - Sidestand3-18
 - Spark plug, checking6-8
 - Specifications8-1
 - Speedometer3-5
 - Start switch3-9
 - Starting off5-2
 - Starting the engine5-1
 - Steering, checking6-24
 - Storage7-3
 - Storage compartments3-15
- T**
- Tail/brake light bulb or rear turn signal light bulb, replacing6-29
 - Throttle cable free play, adjusting6-15
 - Throttle grip and cable, checking and lubricating6-22
 - Tires6-16
 - Tool kit6-1
 - Troubleshooting6-32
 - Troubleshooting charts6-33
 - Turn signal indicator lights3-3
 - Turn signal light bulb (front), replacing6-29
 - Turn signal switch3-9

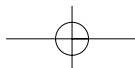

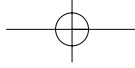

INDEX

V

- Valve clearance6-16
- Vehicle identification number9-1

W

- Wheel bearings, checking6-24
- Wheels6-18

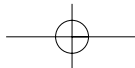

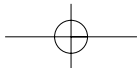
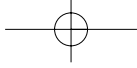

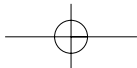
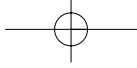

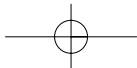
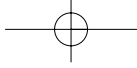

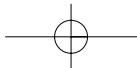
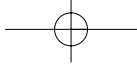



PRINTED IN SPAIN
2008.10-NOVOPRINT, S.A.
(E)

